

# WaveDriver 40 Bipotentiostat/Galvanostat User Guide



Pine Research Instrumentation, Inc.  
2741 Campus Walk Avenue  
Building 100  
Durham, NC 27705  
USA

<https://www.pineresearch.com>

Phone: +1 919.782.8320 Fax: +1 919.782.8323

Copyright © 2021 Pine Research Instrumentation, Inc.



# Table of Contents

<b>1. Preface</b>	<b>1</b>
1.1 Scope	1
1.2 Copyright	1
1.3 Trademarks	1
1.4 Use Limitation	1
1.5 Harmful or Corrosive Substances	2
1.6 Service and Warranty Information	3
1.7 Instrument Markings	4
1.7.1 Serial Number	4
1.7.2 Model Numbers	5
1.8 Icons ( <i>Icônes</i> )	6
1.9 Safety Labels ( <i>Étiquettes de sécurité</i> )	7
1.10 General Safety Warnings ( <i>Avertissements de sécurité généraux</i> )	8
1.11 Electrostatic Discharge Information	11
1.12 Hazardous Material Information	11
1.13 Software License	13
<b>2. Product Specifications</b>	<b>15</b>
2.1 Instrument Description	15
2.2 Software Description	15
2.3 Instrument Specifications	16
2.3.1 WaveDriver 40 Bipotentiostat/Galvanostat Specifications	16
2.4 Standard Electrochemical Methods	20
2.5 System Components	21
2.6 Front Panel	22
2.7 Back Panel	24
2.8 Dummy Cell Description	27
<b>3. System Installation</b>	<b>29</b>
3.1 Physical Installation	29
3.1.1 Location	29
3.1.2 Glovebox Installation	29
3.1.3 Connecting the Power Supply to the Instrument	31
3.1.4 Connecting the Power Supply to the AC Mains	32
3.2 AfterMath Software Installation	33
3.2.1 Step-by-Step Software Installation Instructions	33
3.2.2 Permissions File Verification	39
3.3 USB Cable Connection	42

3.4	Installation Checklist .....	42
<b>4.</b>	<b>System Testing</b>	<b>43</b>
4.1	Test Setup.....	43
4.1.1	Launch the AfterMath Software .....	43
4.1.2	Verify Instrument Status .....	43
4.1.3	Confirm Connections .....	44
4.1.4	Review Instrument Status .....	45
4.2	Single Channel (K1) DC Test.....	45
4.2.1	Connect to the Pine Research Universal Dummy Cell.....	45
4.2.2	Create a Cyclic Voltammetry (CV) Experiment .....	47
4.2.3	Audit Experimental Parameters .....	47
4.2.4	Initiate the Experiment .....	47
4.2.5	Monitor Experimental Progress .....	48
4.2.6	Review the Results .....	49
4.2.7	Understanding the Results .....	49
4.3	Dual Channel (K1 and K2) DC Test .....	52
4.3.1	Connect to the Pine Research Universal Dummy Cell.....	52
4.3.2	Create a Dual Electrode Cyclic Voltammetry (DECV) Experiment .....	52
4.3.3	Modify the Potential Range Setting .....	53
4.3.4	Audit Experimental Parameters .....	53
4.3.5	Initiate the Experiment .....	53
4.3.6	Monitor Experimental Progress .....	53
4.3.7	Review the Results .....	55
4.3.8	Understanding the Results .....	55
<b>5.</b>	<b>Cell Cable Connections</b>	<b>57</b>
5.1	Cell Cable Color Code.....	57
5.2	Experimental Configurations .....	59
5.2.1	Two-Electrode Setups.....	60
5.2.2	Three-Electrode Cells .....	61
5.2.3	Rotating Disk and Rotating Cylinder Electrodes (RDE and RCE) .....	63
5.2.4	Rotating Ring-Disk Electrodes (RRDE) .....	64
5.2.5	Rotation Rate Control .....	65
5.2.6	Compact Voltammetry Cell Cable Connections .....	67
<b>6.</b>	<b>Grounding Information</b>	<b>69</b>
6.1	Common Noise Sources .....	69
6.2	Grounding Terminology .....	69
6.2.1	Earth Ground.....	69
6.2.2	Chassis Terminal .....	71
6.2.3	DC Common .....	71
6.3	Faraday Cages .....	72

6.4	Metal Apparatus .....	73
6.5	USB Isolation .....	73
6.6	Grounding Strategies .....	74
6.7	Grounding Third-Party Instrumentation.....	74
<b>7.</b>	<b>Power Cords</b>	<b>78</b>
<b>8.</b>	<b>Glossary</b>	<b>81</b>
<b>9.</b>	<b>Appendix I: Legacy Dummy Cell Information (before NOV 2020)</b>	<b>84</b>
9.1	Legacy Dummy Cell Description .....	84
9.2	Connecting to Row "C" on the Universal Dummy Cell.....	85
<b>10.</b>	<b>Appendix II. Legacy Grounding Information (before APR 2021)</b>	<b>86</b>
<b>11.</b>	<b>Customer Support</b>	<b>88</b>
11.1	Online .....	88
11.2	By E-mail.....	88
11.3	By Phone .....	88

# Table of Tables

Table 1-1. WaveDriver Instrument Model Numbers and Model Names .....	5
Table 1-2. Special Icons used in this Document. ....	5
Table 1-3. Safety Warning Icons used in this Document. ....	6
Table 1-4. Other Safety Warning Icons used in this Document .....	7
Table 1-5. Hazardous Materials Disclosure (English) .....	12
Table 1-6. Hazardous Materials Disclosure (Mandarin).....	12
Table 2-1. Electrochemical Techniques in AfterMath.....	20
Table 2-2. Main Components Included with WaveDriver 40 Bipotentiostat .....	21
Table 2-3. Front Panel of the WaveDriver 40 Bipotentiostat.....	22
Table 2-4. Overview of WaveDriver 40 Bipotentiostat LED Indicator Lights.....	23
Table 2-5. WaveDriver 40 Back Panel Connector Descriptions.....	25
Table 3-1. Computer System Requirements for AfterMath Software .....	33
Table 5-1. WaveDriver 40 Cell Cable Color Description.....	57
Table 7-1. Select Power Cords Available from Pine Research .....	80

# Table of Figures

Figure 1-1. WaveDriver 40 Instrument Markings .....	4
Figure 1-2. Safety Warning Labels on Back Panel of Instrument .....	7
Figure 2-1. WaveDriver 40 Back Panel Connections.....	24
Figure 2-2. WaveDriver 40 Control Ports A, B, and C Pinouts .....	26
Figure 2-3. WaveDriver 40 Pine Research Universal Dummy Cell (with Schematic Diagrams) .....	27
Figure 3-1. USB Cable Glovebox Feedthrough.....	30
Figure 3-2. Cell Cable Glovebox Feedthrough .....	30
Figure 3-3. Power Supply with Low Voltage (24 VDC) Cable Connection to Back Panel.....	31
Figure 3-4. Welcome to AfterMath Setup Wizard Dialog Box .....	34
Figure 3-5. AfterMath Installation License Agreement .....	34
Figure 3-6. AfterMath Installation Options .....	35
Figure 3-7. Selecting AfterMath Installation Folder and User Access.....	35
Figure 3-8. Confirm Installation of AfterMath .....	36
Figure 3-9. Installation Progress of AfterMath.....	36
Figure 3-10. Device Driver Installation Wizard .....	37
Figure 3-11. USB/Device Driver Installation Progress.....	37
Figure 3-12. USB/Device Driver Installation Completion .....	38
Figure 3-13. Windows Security Prompt to Install Device Software .....	38
Figure 3-14. Confirmation of Successful AfterMath Installation .....	39
Figure 3-15. Permissions Files on Installation Media .....	40
Figure 3-16. Indications that the AfterMath License is not Active .....	40
Figure 3-17. Copying Permissions Files to AfterMath .....	41
Figure 3-18. USB Cable Connection Between Potentiostat and Computer.....	42
Figure 4-1. Initial Login Screen when Starting AfterMath.....	43
Figure 4-2. AfterMath Screenshot with Connected Instrument Circled .....	44
Figure 4-3. Indicator Lights on the Front Panel of the WaveDriver 40.....	44
Figure 4-4. AfterMath Instrument Status Window showing External Cell Idle Conditions .....	45
Figure 4-5. WaveDriver 40 Cell Cable Connected to "Cell C" of Dummy Cell.....	46
Figure 4-6. Cyclic Voltammetry (CV) Parameters Dialog Window .....	47
Figure 4-7. Location of Instrument Selection Menu and Perform Button .....	48
Figure 4-8. Monitoring the Progress of the CV Experiment.....	49
Figure 4-9. Anticipated CV Results (using "Cell C" of Dummy Cell) .....	50
Figure 4-10. Analyzed CV Results (using "Cell C" of Dummy Cell).....	51
Figure 4-11. Dual Electrode Cyclic Voltammetry (DECV) Parameters Dialog Window.....	52
Figure 4-12. Adjusting the Potential Ranges on the "Ranges" Tab (DECV) .....	53
Figure 4-13. Location of Instrument Selection Menu and Perform Button (DECV).....	54
Figure 4-14. Monitoring the Progress of the DECV Experiment (K1 and K2) .....	54
Figure 4-15. Anticipated DECV Results (using "Cell C" of Dummy Cell) .....	55
Figure 4-16. Analyzed DECV Results (using "Cell C" of Dummy Cell) .....	56
Figure 5-1. WaveDriver 40 Cell Port and Cell Cable Pinout .....	58

Figure 5-2. Secure Connection of the WaveDriver 40 Cell Cable to the Cell Port .....	59
Figure 5-3. Unused K2 Electrode Lines .....	59
Figure 5-4. Examples of Two-Electrode Setups .....	60
Figure 5-5. Typical Three-Electrode Cell Configuration .....	62
Figure 5-6. Working Electrode Sense and Drive Leads (K1) Shorted Together near the Electrode .....	63
Figure 5-7. Working Electrode Connection for a Rotating Disk or Rotating Cylinder Electrode .....	64
Figure 5-8. Electrode Connections for a Rotating Ring-Disk Electrode .....	65
Figure 5-9. Rotation Rate Control Connections for a Pine Research MSR Rotator .....	66
Figure 5-10. Rotation Rate Control Connections for a Pine Research WaveVortex 10 Rotator .....	67
Figure 5-11. Cable Connections for the Compact Voltammetry Cell Kit .....	68
Figure 6-1. Location of Earth Ground on Common Electrical Receptacles .....	70
Figure 6-2. A Typical Earth Ground Connection Adapter with Banana Cable .....	70
Figure 6-3. Common Examples of Faraday Cages .....	73
Figure 6-4. Metal Objects Near the Electrochemical Cell Should Be Grounded .....	73
Figure 6-5. Four Common Instrument Grounding Configurations .....	75
Figure 6-6. Connect All Instrument Chassis Terminals to a Common Point .....	76
Figure 9-1. WaveDriver 40 Universal Dummy Cell (with Schematic Diagrams) .....	84
Figure 9-2. WaveDriver 40 Cell Cable Connected to Universal Dummy Cell Row "C" .....	85
Figure 10-1. Four Common Instrument Grounding Configurations .....	87



---

## 1. Preface

### 1.1 Scope

This user guide describes the WaveDriver 40 Bipotentiostat/Galvanostat system. The target audience for this user guide is a professional scientist or engineer (or student of science and engineering) with a basic knowledge of scientific measurement, data presentation, and electrochemistry. Practical aspects of making electrochemical measurements using the WaveDriver 40 instrument are discussed.

A small portion of this guide is dedicated to the subject of using the AfterMath software package to control the WaveDriver 40 instrument. This information about AfterMath is limited primarily to the subject of installing the software, connecting to the instrument, and verifying that the system works correctly. More extensive descriptions of how to use the AfterMath software may be found in the documents listed below:

- *AfterMath User Guide* (describes plotting and analysis functions)
- *AfterMath Electrochemistry Guide* (describes electrochemical techniques)

Both of the additional documents listed above are available online at the following URL:

<https://www.pineresearch.com/shop/knowledgebase/>

### 1.2 Copyright

This publication may not be reproduced or transmitted in any form, electronic or mechanical, including photocopying, recording, storing in an information retrieval system, or translating, in whole or in part, without the prior written consent of Pine Research Instrumentation, Inc.

### 1.3 Trademarks

All trademarks are the property of their respective owners. *Windows* is a registered trademark of Microsoft Corporation (Redmond, WA). *WaveDriver*<sup>®</sup>, *WaveVortex*<sup>®</sup> and *AfterMath*<sup>®</sup> are registered trademarks of Pine Research Instrumentation, Inc. (Durham, NC).

### 1.4 Use Limitation

The WaveDriver 40 instrument is not designed for use in experiments involving human subjects and/or the use of electrodes inside or on the surface of the human body.

Any use of this instrument other than its intended purpose is prohibited.

## 1.5 Harmful or Corrosive Substances

The operator of the WaveDriver 40 should have prior experience working in a chemical laboratory and knowledge of the safety issues associated with working in chemical laboratory. Electrochemical experiments may involve the use of harmful or corrosive substances, and the operator should wear personal protective equipment while working with these substances. At a minimum, the operator should wear the following items to avoid contact with harmful or corrosive substances:

- Eye protection (safety goggles, face shield, etc.)
- Laboratory coat (flame resistant and solvent resistant)
- Solvent-resistant gloves
- Closed-toe shoes

Additional personal protective clothing and equipment may be required depending upon the nature of the chemicals used in an experiment. A complete discussion of chemical laboratory safety practices is beyond the scope of this user guide, and the reader is directed to the CHEMICAL SAFETY BIBLIOGRAPHY below for additional information.

### CHEMICAL SAFETY BIBLIOGRAPHY BIBLIOGRAPHIE DE SÉCURITÉ CHIMIQUE

1. American Chemical Society Committee on Chemical Safety Hazards Identification and Evaluation Task Force, *Identifying and Evaluating Hazards in Research Laboratories: Guidelines Developed by the Hazards Identification and Evaluation Task Force of the ACS Committee on Chemical Safety*; American Chemical Society, 2013.
2. National Research Council (US), Division of Earth and Life Studies, Board of Chemical Sciences and Technology, Committee on Prudent Practices in the Laboratory, *Prudent Practices in the Laboratory: Handling and Management of Chemical Hazards, Updated Version*; National Academies Press, 2011.
3. American Chemical Society Committee on Chemical Safety. *Safety in Academic Chemistry Laboratories*; 7th ed.; American Chemical Society: State College, PA, 2003; Vol. 2.

L'opérateur du WaveDriver 40 doit avoir une expérience préalable de travail dans un laboratoire de chimie et la connaissance des mesures de sécurité associées aux travaux dans un laboratoire de chimie. Les expériences en électrochimie peuvent impliquer l'utilisation de substances nocives ou corrosives, et l'opérateur doit porter des équipements de protection individuelle lorsqu'il travaille avec ces substances. Au minimum, l'opérateur doit porter les articles suivants pour éviter le contact avec les substances nocives ou corrosives :

- Protection des yeux (lunettes de sécurité, masque de protection facial, ect.)
- Blouse de laboratoire (résistante au feu et résistante aux solvants)
- Gants de protection résistants aux solvants
- Chaussures fermées

Des vêtements et équipements de protection individuelle supplémentaires peuvent être requis en fonction de la nature des produits chimiques utilisés dans une expérience. Une discussion complète des pratiques de sécurité de laboratoire chimique est au-delà de la portée de ce guide de l'utilisateur, et le lecteur est dirigé vers la « BIBLIOGRAPHIE DE SÉCURITÉ CHIMIQUE » ci-dessus pour des informations supplémentaires.

## 1.6 Service and Warranty Information

For questions about proper operation of the WaveDriver 40 system or other technical issues, please use the contact information below to contact Pine Research directly.

### TECHNICAL SERVICE CONTACT

Pine Research Instrumentation, Inc.  
<https://www.pineresearch.com>  
 Phone: +1 (919) 782-8320  
 Fax: +1 (919) 782-8323  
 Email: [pinewire@pineresearch.com](mailto:pinewire@pineresearch.com)

If the WaveDriver 40 system or one of its components or accessories must be returned to the factory for service, please contact Technical Service (see above) to obtain a Return Material Authorization (RMA) form. Include a copy of this RMA form in each shipping carton and ship the cartons to the Factory Return Service Address (below).

### FACTORY RETURN SERVICE ADDRESS

Pine Instrument Company  
 ATTN: RMA # <RMA number>  
 104 Industrial Drive  
 Grove City, PA 16127  
 USA



### RETURN MATERIAL AUTHORIZATION REQUIRED!

**Do not ship equipment to the factory without first obtaining a Return Material Authorization (RMA) from Pine Research.**

### LIMITED WARRANTY

The WaveDriver 40 Bipotentiostat/Galvanostat instrument (hereafter referred to as the "INSTRUMENT") offered by Pine Research Instrumentation (hereafter referred to as "PINE") is warranted to be free from defects in material and workmanship for a one (1) year period from the date of shipment to the original purchaser (hereafter referred to as the "CUSTOMER") and used under normal conditions. The obligation under this warranty is limited to replacing or repairing parts which shall upon examination by PINE personnel disclose to PINE's satisfaction to have been defective. The customer may be obligated to assist PINE personnel in servicing the INSTRUMENT. PINE will provide telephone support to guide the CUSTOMER to diagnose and effect any needed repairs. In the event that telephone support is unsuccessful in resolving the defect, PINE may recommend that the INSTRUMENT be returned to PINE for repair. This warranty being expressly in lieu of all other warranties, expressed or implied and all other liabilities. All specifications are subject to change without notice.

The CUSTOMER is responsible for charges associated with non-warranted repairs. This obligation includes but is not limited to travel expenses, labor, parts and freight charges.



## 1.7 Instrument Markings

Labels located on the back panel of each individual WaveDriver 40 include information about the make, model, and serial number of the instrument. These labels also indicate any certifications or independent testing agency marks that pertain to the instrument (see Figure 1-1).

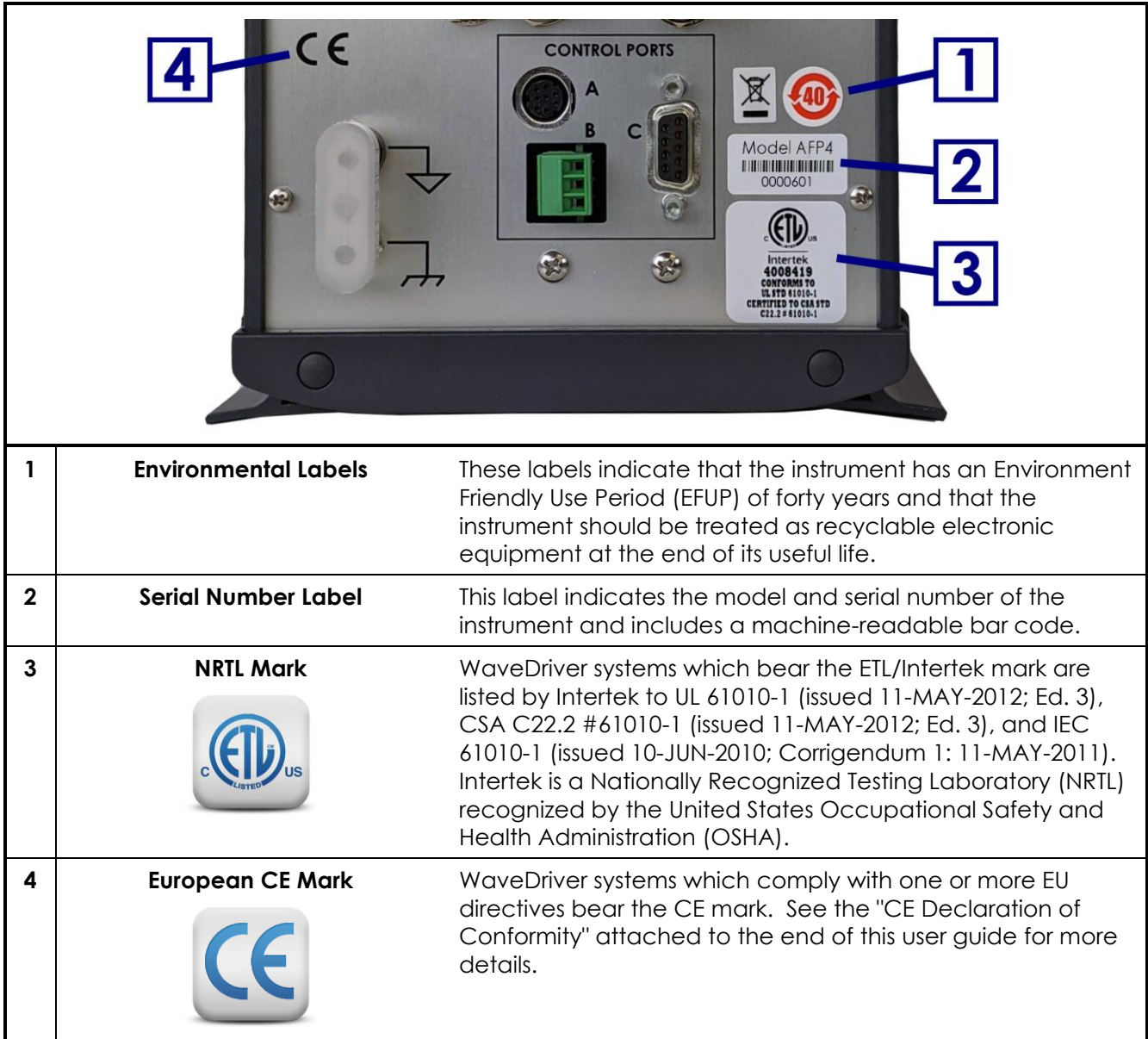

Figure 1-1. WaveDriver 40 Instrument Markings

### 1.7.1 Serial Number

For purposes of uniquely identifying a particular instrument, there is a label on the back panel of each WaveDriver 40 instrument that indicates the model number and the serial number. The serial number is also encoded with a machine-readable barcode on the same label (see Figure 1-1).

## 1.7.2 Model Numbers

The relationship between the model name and model number for the WaveDriver 40 system is described below (see Table 1-1). The model number has the format “AFP $\mathbf{N}$ XY” where  $\mathbf{N}$  is a single numeric digit (either 3 or 4), and  $\mathbf{X}$  and  $\mathbf{Y}$  are either blank or uppercase alphabetic characters. Pine Research part numbers for various components of the system (such as power cords, cell cables, and accessories) are described in more detail later (see Sections 5 and 7).

Model Number:	A	F	P	N	X	Y	Model Name
	A	F	P	4			<b>WaveDriver 40</b>
	A	F	P	3			<b>WaveDriver 200</b>
	A	F	P	5			<b>WaveDriver 100</b>

**Table 1-1. WaveDriver Instrument Model Numbers and Model Names**

The WaveDriver 200 is similar to the WaveDriver 40, but it may also be used to perform Electrochemical Impedance Spectroscopy (EIS) methods. The WaveDriver 100 is a potentiostat/galvanostat (meaning it has only one working electrode channel unlike the WaveDriver 40, which is a bipotentiostat and has two), and it may also be used to perform EIS methods.

	<p><b>STOP:</b> For a procedure involving user action or activity, this icon indicates a point in the procedure where the user must stop the procedure.</p> <p><b>ARRÊT:</b> <i>Dans une opération impliquant l'action ou l'activité d'un utilisateur, cette icône indique l'étape où l'utilisateur doit arrêter l'opération.</i></p>
	<p><b>NOTE:</b> Important or supplemental information.</p> <p><b>REMARQUE:</b> <i>Renseignements importants ou complémentaires.</i></p>
	<p><b>TIP:</b> Useful hint or advice.</p> <p><b>CONSEIL:</b> <i>Astuce ou conseil utile.</i></p>

**Table 1-2. Special Icons used in this Document.**

*(Tableau 1-2. Icônes spéciales utilisées dans ce document)*

## 1.8 Icons (Icônes)

Special icons are used to call attention to safety warnings and other useful information found in this document (see Table 1-2, Table 1-3, and Table 1-4).

*Des icônes spéciales (voir Tableau 1-2, Tableau 1-3, et Tableau 1-4) sont utilisées pour attirer l'attention sur des avertissements de sécurité et d'autres renseignements utiles disponibles dans ce document.*



	<p><b>WARNING:</b> Indicates information needed to prevent injury or death to a person or to prevent damage to equipment.</p> <p><b>AVERTISSEMENT:</b> Indique les informations nécessaires pour prévenir les blessures ou le décès d'une personne ou pour éviter d'endommager l'équipement.</p>
	<p><b>ROTATING SHAFT HAZARD:</b> Indicates information needed to prevent injury or death to a person due to a high-speed rotating shaft.</p> <p><b>DANGER LIÉ À LA ROTATION DE L'ARBRE:</b> <i>Indique les informations nécessaires pour prévenir les blessures ou le décès d'une personne à cause de la vitesse élevée de rotation de l'arbre.</i></p>
	<p><b>RISK OF ELECTRICAL SHOCK:</b> Indicates information needed to prevent injury or death to a person due to electrical shock.</p> <p><b>RISQUE DE DÉCHARGE ÉLECTRIQUE:</b> <i>Indique les informations nécessaires pour prévenir les blessures ou le décès d'une personne à cause d'une décharge électrique.</i></p>

Table 1-3. Safety Warning Icons used in this Document.

*(Tableau 1-3. Icônes d'avertissement de sécurité utilisées dans ce document)*



	<p><b>CAUTION:</b> Indicates information needed to prevent damage to equipment.</p> <p><b>ATTENTION:</b> Indique les informations nécessaires pour éviter d'endommager l'équipement.</p>
	<p><b>RISK OF ELECTROSTATIC DAMAGE:</b> Indicates information needed to prevent damage to equipment due to electrostatic discharge.</p> <p><b>RISQUE DE DOMMAGES ÉLECTROSTATIQUES:</b> <i>Indique les informations nécessaires pour éviter d'endommager l'équipement à cause d'une décharge électrostatique.</i></p>
	<p><b>TEMPERATURE CONSTRAINT:</b> Indicates when an operation or use of equipment is limited to a specified temperature range.</p> <p><b>CONTRAINTES DE TEMPÉRATURE :</b> <i>Indique lorsqu'une opération ou un usage de matériel est limité à une plage de températures spécifique.</i></p>

Table 1-4. Other Safety Warning Icons used in this Document

(Tableau 1-4: Autres Icônes d'avertissement de sécurité utilisées dans ce document)

## 1.9 Safety Labels (Étiquettes de sécurité)

Specific safety warnings are found on labels attached to the instrument (see Figure 1-2).

Les avertissements de sécurité spécifiques suivants se trouvent sur les étiquettes apposées sur l'instrument (voir Figure 1-2).

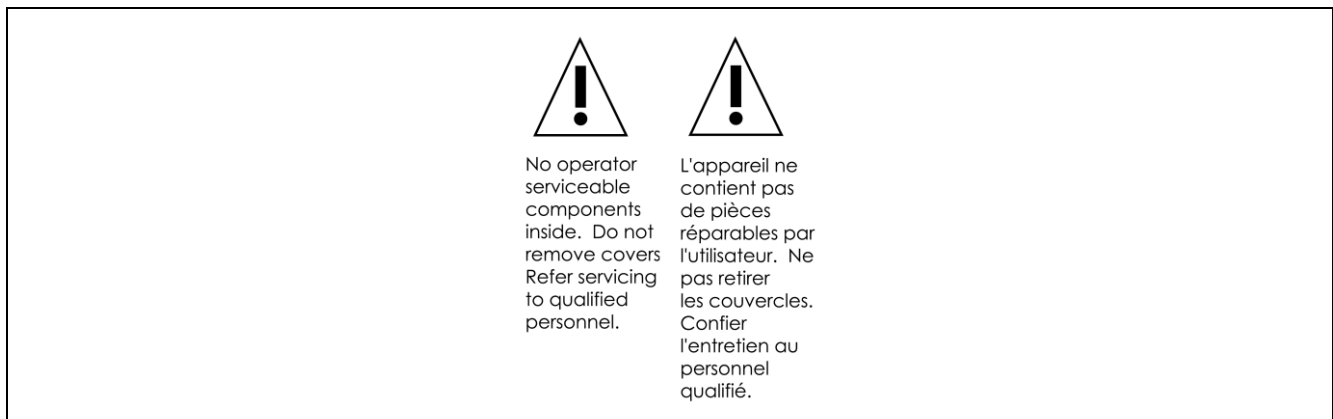

Figure 1-2. Safety Warning Labels on Back Panel of Instrument

## 1.10 General Safety Warnings (Avertissements de sécurité généraux)

The following safety warnings pertain to general use of the instrument. More specific safety warnings are found in later sections of this document that pertain to particular operations and procedures involving the instrument.

*Des avertissements de sécurité plus spécifiques se trouvent dans les sections suivantes de ce document, concernant les opérations et les procédures particulières relatives à l'instrument.*



**WARNING:**

There are no user serviceable components inside the WaveDriver 40 chassis. Do not remove the chassis covers. Refer any service issue to qualified personnel.

**AVERTISSEMENT:**

*Le châssis de l'appareil WaveDriver 40 ne comporte aucune pièce pouvant être remplacée par l'utilisateur. Ne retirez pas les protections du châssis. Signalez tout problème d'entretien au personnel qualifié.*



**WARNING:**

A factory-approved power supply is provided with the WaveDriver 40. Do not use a power supply that is not factory-approved.

**AVERTISSEMENT:**

*Une alimentation électrique approuvée par le constructeur est fournie avec l'appareil WaveDriver 40. N'utilisez pas une alimentation électrique non approuvée par le constructeur.*



**WARNING:**

Connect the power supply to the AC mains using the power cord supplied with the WaveDriver 40 and certified for the country of use (see Section 7 of this User Guide for more details). Do not replace this cord with an inadequately rated cord.

**AVERTISSEMENT:**

*Connectez le bloc d'alimentation au secteur à l'aide du cordon d'alimentation fourni avec l'appareil WaveDriver 40 et conforme aux réglementations du pays d'utilisation (pour plus de détails, consultez la partie 7 du présent mode d'emploi). Ne remplacez pas ce cordon par un cordon de calibre inadéquat.*



**WARNING:**

Do not block access to the power supply or the power cord. The user must have access to disconnect the power supply or the power cord from the AC mains at all times.

**AVERTISSEMENT:**

*Ne bloquez pas l'accès au bloc d'alimentation ou au cordon d'alimentation. L'utilisateur doit être en mesure de déconnecter le bloc d'alimentation ou le cordon d'alimentation du secteur à tout moment.*

**WARNING:**

The switch on the front of the WaveDriver 40 turns the power to the instrument on and off. Do not block access to the switch. The user must have access to the switch at all times.

**AVERTISSEMENT:**

*L'interrupteur situé sur le devant de l'appareil WaveDriver 40 permet de couper l'alimentation. Ne bloquez pas l'accès à l'interrupteur. L'utilisateur doit avoir accès à l'interrupteur à tout moment.*

**WARNING:**

Do not operate the WaveDriver 40 in an explosive atmosphere.

**ATTENTION:**

*N'utilisez pas l'appareil WaveDriver 40 dans une atmosphère explosive.*

**CAUTION**

Provide proper ventilation for the WaveDriver 40. Maintain at least two inches (50 mm) of clearance around the sides (left, right, and back) and above (top) the instrument.

**ATTENTION:**

*Assurez-vous que l'appareil WaveDriver 40 soit correctement ventilé. Laissez au moins 50 mm (2 po) autour de l'appareil (à gauche, à droite et derrière), ainsi qu'au-dessus.*

**CAUTION:**

Do not operate the WaveDriver 40 in wet or damp conditions. Keep all instrument surfaces clean and dry.

**ATTENTION:**

*N'utilisez pas l'appareil WaveDriver 40 dans un environnement mouillé et humide. Veillez à ce que toutes les surfaces de l'appareil soient toujours propres et sèches.*

**CAUTION:**

Do not operate the WaveDriver 40 if it has suffered damage or is suspected of having failed. Refer the instrument to qualified service personnel for inspection.

**ATTENTION:**

*N'utilisez pas l'appareil WaveDriver 40 s'il a été endommagé ou si vous pensez qu'il est tombé en panne. Signalez l'appareil au personnel d'entretien qualifié pour qu'il soit examiné.*

**WARNING:**

Rotating shaft.

When connecting a WaveDriver 40 system to an electrode rotator other than the Pine Research MSR or WaveVortex 10 rotator, carefully consider the magnitude of the WaveDriver 40 rate control signal ratio (1 RPM/mV) and take steps to assure that the rotator is configured to use the same ratio.

Use extreme caution when operating the rotator at rotation rates above 2000 RPM.

**AVERTISSEMENT:**

*Arbre tournant.*

*Lorsque vous connectez un système WaveDriver 40 à une électrode tournante autre que le MSR ou le WaveVortex 10 de Pine Research, prenez en compte soigneusement le rapport du signal de contrôle de vitesse du WaveDriver 40 (1 [tr/min]/mV) et assurez-vous que l'électrode tournante est configurée avec le même rapport.*

*Soyez extrêmement prudent lorsque vous utilisez l'électrode tournante à des vitesses de rotation supérieures à 2000 tr/min.*

## 1.11 Electrostatic Discharge Information

Electrostatic discharge (ESD) is the rapid discharge of static electricity to ground. An ESD event occurs when two bodies of different potential approach each other closely enough such that static charge rapidly passes from one object to the next. Sensitive electronics in the path of the discharge may suffer damage. Damaging ESD events most often arise between a statically charged human body and a sensitive electronic circuit. The human body can easily accumulate static charge from simple movement from one place to another (*i.e.*, walking across a laboratory).

Potentiostat users must always be aware of the possibility of an ESD event and should employ good practices to minimize the chance of damaging the instrument. Some examples of good ESD prevention practices include the following:

- Self-ground your body before touching sensitive electronics or the electrodes. Self-grounding may be done by touching a grounded metal surface such as a metal pipe.
- Wear a conductive wrist-strap connected to a good earth ground to prevent a charge from building up on your body.
- Wear a conductive foot/heel strap or conductive footwear in conjunction with standing on a grounded conductive floor mat.
- Increase the relative humidity in the air to minimize static generation.

The WaveDriver 40 has been tested and found to be compliant with the European EMC product specific Standard EN 61326-1:2013 for immunity and emissions. The immunity standard includes testing for ESD to IEC 61000-4-2:2008.



**INFO:**

**The WaveDriver 40 instrument may be susceptible to ESD events that occur on or near the electrode cable assembly. Such an ESD event can result in data loss, corruption of data, loss of communication with PC, and instrument unresponsiveness. Addition of a metallic shield to the electrode cable will improve the immunity of the system to an ESD event.**

## 1.12 Hazardous Material Information

Disclosure tables in both English and Mandarin are provided (see Table 1-5 and Table 1-6) that detail information pertaining to the list of hazardous substances classified under the Restriction of Hazardous Substances Directive (RoHS).

Hazardous Material Disclosure Table						
AFP4						
Part Name	Hazardous Substances					
	Lead (Pb)	Mercury (Hg)	Cadmium (Cd)	Hexavalent Chromium (Cr (VI))	Polybrominated biphenyls (PBB)	Polybrominated diphenyl ethers (PBDE)
Analog PCB Assy.	X	○	○	○	○	○
Digital PCB Assy.	X	○	○	○	○	○
Dummy Cell Assy.	X	○	○	○	○	○

This table is prepared in accordance with the provisions of SJ/T 11364

○: indicates that said hazardous substance contained in all of the homogeneous materials for this part is below the limit requirements of GB/T 26572.

X: indicates that said hazardous substance contained in at least one of the homogeneous materials for this part is above the limit requirements of GB/T 26572.

Note: the date of manufacture for this item may be coded in the serial number as follows:  
wwwyy6nn: ww indicates week; yy indicates year; and nn is the number of the item, starting with 01 each week.

Table 1-5. Hazardous Materials Disclosure (English)

有害物质披露表						
AFP4						
	铅	汞	镉	六价铬	多溴联苯	多溴二苯醚
	(Pb)	(Hg)	(Cd)	(Cr (VI))	(PBB)	(PBDE)
模拟电路板	X	○	○	○	○	○
数字电路板	X	○	○	○	○	○
虚拟电解池	X	○	○	○	○	○

本表格依据 SJ/T 11364 的规定编制。

○：表示该有害物质在该部件所有均质材料中的含量均在 GB/T 26572 规定的限量要求以下。

X：表示该有害物质至少在该部件的某一均质材料中的含量超出 GB/T 26572 规定的限量要求。

注：该部件的制造日期可能会按照以下格式出现在序列号码中：  
wwwyy6nn：ww 表示周数；yy 表示年的最后两位数；nn 是该周序列号、每周都从01开始。

Table 1-6. Hazardous Materials Disclosure (Mandarin)

## 1.13 Software License

Purchase of a WaveDriver 40 instrument includes a license to use the AfterMath software package to control the instrument and analyze data collected using the instrument. Pine Research understands that the WaveDriver 40 is used in a laboratory environment where multiple computers are present and where data acquired using one computer might be analyzed using a different computer. The following software license describes how AfterMath may be used with the WaveDriver 40 in a laboratory with multiple computers.

### PINE RESEARCH INSTRUMENTATION AFTERMATH DATA ORGANIZER SOFTWARE LICENSE

Pine Research Instrumentation, Inc. (hereafter "PINE") licenses purchasers (hereafter "LICENSEES") of Pine electrochemical potentiostats (hereafter "INSTRUMENTS") to use the AfterMath Data Organizer software (hereafter "SOFTWARE") in conjunction with these INSTRUMENTS. This License contains the terms and conditions of use of the SOFTWARE.

1. **Scope of License:** This License covers the software, user documentation and any related computer programs provided by PINE for use with one or more specific INSTRUMENTS. This License does not grant any proprietary or ownership rights in the SOFTWARE or related technology. The scope of this License is limited to an exclusive group of one or more specific INSTRUMENTS, where the members of this exclusive group are specifically enumerated and identified by make, model, and serial number at the time this License is purchased. The one or more specific INSTRUMENTS belonging to this exclusive group are hereafter referred to as the "DESIGNATED INSTRUMENTS".
2. **License:** PINE grants to LICENSEE a nonexclusive, nontransferable license to use the SOFTWARE in object code form on any computer which is connected to the DESIGNATED INSTRUMENTS for purposes of controlling the operation of the DESIGNATED INSTRUMENTS. The LICENSEE is not authorized to use the SOFTWARE to control the operation of any instruments other than the DESIGNATED INSTRUMENTS. PINE further grants to LICENSEE a nonexclusive, nontransferable license to use the SOFTWARE in object code form on up to five (5) other computers which are not connected to the DESIGNATED INSTRUMENTS for the sole purpose of analyzing data previously generated by the DESIGNATED INSTRUMENTS. PINE further grants permission to LICENSEE to make one (1) archival copy of the SOFTWARE for back-up purposes if required. Except as expressly authorized above, LICENSEE shall not: copy, in whole or in part, any of the SOFTWARE or documentation, modify the SOFTWARE, reverse engineer, reverse compile (de-compile), or reverse assemble all or any portion of the SOFTWARE, or rent, lease, distribute, sell or create derivative works of the SOFTWARE.
3. **Term and Termination:** The License hereby granted will continue in force until terminated, as set forth herein. If LICENSEE fails to pay any monies owed to PINE or its agents in connection with LICENSEE's purchase of the DESIGNATED INSTRUMENTS or this SOFTWARE, or violates any term of condition of this License, PINE or its agents may terminate this License immediately by giving notice of termination to LICENSEE.
4. **Limited Warranty:** PINE warrants the SOFTWARE to conform to the description of its function and performance. In the event that the SOFTWARE does not perform in accordance with this warranty, PINE agrees to repair or fix any non-conformity free of charge, or to refund any amount paid by LICENSEE for the SOFTWARE. Any modifications made to the SOFTWARE by LICENSEE shall void this warranty entirely.
5. **DISCLAIMER OF WARRANTY FOR SOFTWARE.** EXCEPT FOR THE EXPRESS WARRANTIES SET FORTH IN THIS AGREEMENT, PINE DISCLAIMS ALL IMPLIED WARRANTIES FOR THE SOFTWARE, INCLUDING WARRANTIES OF MERCHANTABILITY AND FITNESS FOR A PARTICULAR PURPOSE. PINE MAKES NO



REPRESENTATIONS CONCERNING THE QUALITY OF THE SOFTWARE AND DOES NOT PROMISE THAT THE SOFTWARE WILL BE ERROR FREE OR WILL OPERATE WITHOUT INTERRUPTION.

6. **LIMITATION OF LIABILITY.** IN NO EVENT WILL PINE BE LIABLE FOR ANY DIRECT, INDIRECT, INCIDENTAL, SPECIAL, CONSEQUENTIAL OR OTHER DAMAGES ARISING OUT OF THE USE OF OR INABILITY TO USE THE SOFTWARE BY ANY PERSON, REGARDLESS OF WHETHER PINE IS INFORMED OF THE POSSIBILITY OF DAMAGES IN ADVANCE. THESE LIMITATIONS APPLY TO ALL CAUSES OF ACTION, INCLUDING BREACH OF CONTRACT, BREACH OF WARRANTY, PINE'S NEGLIGENCE, STRICT LIABILITY, MISREPRESENTATION AND OTHER TORTS. In no event shall PINE's liability or liability of PINE's suppliers exceed the price paid by the LICENSEE for the SOFTWARE. The foregoing limitations shall apply even if the above-stated warranty fails of its essential purpose.
7. **Ownership of SOFTWARE:** PINE has and will retain all ownership rights in the SOFTWARE, including all patent rights, copyrights, trade secrets, trademarks, service marks, related goodwill and confidential and proprietary information. LICENSEE will have no rights in the SOFTWARE except as explicitly stated in this Agreement. Title to the SOFTWARE and documentation remains solely with PINE. LICENSEE may not assign this Agreement or any rights under it and may not delegate any duties under this Agreement without PINE's prior written consent. Any attempt to assign or delegate without such consent will be void.
8. **Confidential Information:** LICENSEE agrees that aspects of the SOFTWARE embody or constitute trade secrets and/or copyrighted material of PINE. LICENSEE agrees not to disclose, provide, or otherwise make available such trade secrets or copyrighted material in any form to any third party without the prior written consent of PINE. LICENSEE agrees to implement reasonable security measures to protect such trade secrets and copyrighted material.
9. **Applicable Law:** This License shall be governed by and construed in accordance with the laws of the State of Pennsylvania, United States of America, as if performed wholly within the State and without giving effect to the principles of conflict of law. If any portion hereof is found to be void or unenforceable, the remaining provisions of this License shall remain in full force and effect. This License constitutes the entire understanding and agreement between the parties with respect to the licensed use of the SOFTWARE.
10. **Modifications, Taxes:** Any modification of this Agreement must be in writing and signed by PINE and LICENSEE. Terms and conditions set forth in any purchase order which differ from, conflict with, or are not included in this Agreement, shall not become part of this License unless specifically accepted by PINE in writing. LICENSEE shall be responsible for and shall pay, and shall reimburse PINE on request if PINE is required to pay, any sales, use, value added (VAT), consumption or other tax (excluding any tax that is based on PINE's net income), assessment, duty, tariff, or other fee or charge of any kind or nature that is levied or imposed by any governmental authority on the SOFTWARE.

LICENSEE HAS READ THIS AGREEMENT AND UNDERSTANDS AND AGREES TO ALL OF ITS TERMS AND CONDITIONS.

## 2. Product Specifications

### 2.1 Instrument Description

The WaveDriver 40 is a benchtop instrument that is controlled by a personal computer (via a USB cable) using the AfterMath software package developed by Pine Research. The WaveDriver 40 may be operated as a potentiostat, a galvanostat, or as a bipotentiostat. The instrument is most often used to control the potential (or current) at one or two working electrodes located in an electrochemical cell along with a counter electrode and a suitable reference electrode. Popular DC electrochemical test methods (such as Cyclic Voltammetry, Chronoamperometry, Pulse and Square Wave Voltammetry, etc.) may be performed using the WaveDriver 40.

The working electrodes feature three potential ranges ( $\pm 2.5$  V,  $\pm 10.0$  V, and  $\pm 15.0$  V) and eight current ranges (from  $\pm 1.0$  A down to  $\pm 100.0$  nA), making the WaveDriver 40 suitable for use with a wide variety of electrochemical cells. Because the WaveDriver 40 can control two independent working electrodes (*i.e.*, it can operate as a *two-channel potentiostat* or *bipotentiostat*), the instrument may be used with dual electrode configurations such as the rotating ring-disk electrode (RRDE).

### 2.2 Software Description

The AfterMath scientific data analysis and instrument control software developed by Pine Research is included with each WaveDriver 40 instrument. AfterMath offers several important benefits:

- **Instrument Control.** When started, AfterMath automatically detects all compatible instrumentation attached to the computer and provides complete control over each instrument. AfterMath can simultaneously control multiple instruments, and multiple experiments may be queued on each individual instrument. Even as new experiments are queued or running in the background, data acquired in previous experiments may be manipulated by the user.
- **Flexible Plotting.** AfterMath has a powerful "drag-n-drop" feature that allows traces from one plot to be quickly and easily copied and moved to other plots. Preparing an overlay plot from several voltammograms is straightforward. AfterMath provides precise control over line sizes, point markers, colors, axis limits, axis labels, and tick marks. One or more text boxes may be placed anywhere on a plot, and the text may be formatted with any combination of fonts, font sizes, or colors as desired.
- **Scientific Units.** Unlike graphing software designed for business and marketing applications, AfterMath is designed with scientific data in mind. Proper management of scientific units, metric prefixes, scientific notation, and significant figures are built into Aftermath. For example, if an operation divides a potential measured in millivolts by a current measured in nanoamperes, then Aftermath properly provides the result as a resistance measured in megaohms.
- **Data Archiving.** A unique and open XML-based file format allows data from several related experiments to be stored together in one single archive file. Keeping related experiments together in an archive file eliminates the need to manage multiple individual data files on the hard drive. The internal archive hierarchy can contain as many subfolders, reports, plots, notes, experimental parameters, and data sets as desired.
- **Tools and Transforms.** Flexible tools can be placed on any graph to precisely measure quantities like peak height and peak area. Multiple tools can be placed on a plot, and all such tools remain exactly where they are placed, even if the data archive is saved to a disk and reloaded at a later time. Fundamental mathematical operations (addition, multiplication, integration, logarithm, etc.) can be applied to any trace on any plot.



## 2.3 Instrument Specifications

The WaveDriver 40 instrument offers the following electrode control modes: potentiostatic (POT), galvanostatic (GAL), open circuit potential (OCP), and zero resistance ammeter (ZRA). Uncompensated resistance ( $R_u$ ) measurement and compensation is available via current interrupt and positive feedback techniques.



**INFO:**

**All specifications provided in this section are subject to change without notice.**

### 2.3.1 WaveDriver 40 Bipotentiostat/Galvanostat Specifications

ELECTRODE CONNECTIONS	
<b>Reference Electrode</b>	Sense line with driven shield
<b>Counter Electrode</b>	Drive line with grounded shield
<b>First Working Electrode (K1)</b>	Separate sense and drive lines, each with driven shield (current measurement via passive shunt)
<b>Second Working Electrode (K2)</b>	Separate sense and drive lines, each with driven shield (current measurement via transimpedance amplifier)
GROUND CONNECTIONS	
<b>DC Common (signal ground)</b>	The DC Common is isolated from the USB port, the instrument chassis and earth ground. The DC Common is accessible via a banana jack (black) on the back panel.
<b>Chassis Terminal</b>	The instrument chassis terminal is accessible via a banana jack (metal) on the back panel. The GRAY banana plug on the cell cable also provides a chassis connection to allow convenient connection of the instrument chassis to a Faraday cage surrounding the electrochemical cell.
<b>Earth Ground</b>	No direct connection to earth ground is provided.

(specifications table is continued on the next page)



<b>MEASURED CURRENT</b>	
<b>Ranges</b>	$\pm 1$ A, $\pm 100$ mA, $\pm 10$ mA, $\pm 1$ mA, $\pm 100$ $\mu$ A, $\pm 10$ $\mu$ A, $\pm 1$ $\mu$ A, $\pm 100$ nA
<b>Resolution (at each range)</b>	31.3 $\mu$ A, 3.13 $\mu$ A, 313 nA, 31.3 nA, 3.13 nA, 313 pA, 31.3 pA, 3.13 pA
<b>Autoranging</b>	Yes
<b>Practical Range<sup>s</sup></b>	5 pA to 1.0 A
<b>Accuracy</b>	$\pm 0.2\%$ of setting; $\pm 0.05\%$ of range
<b>Leakage Current</b>	< 10 pA at 25°C
<b>ADC Input</b>	16 bits
<b>Filters</b>	10 Hz, 30 Hz, 100 Hz, 1 kHz, 10 kHz (2-pole, low pass Bessel filters)
<b>APPLIED CURRENT (GALVANOSTATIC MODE)</b>	
<b>Ranges</b>	$\pm 1$ A, $\pm 100$ mA, $\pm 10$ mA, $\pm 1$ mA, $\pm 100$ $\mu$ A, $\pm 10$ $\mu$ A, $\pm 1$ $\mu$ A, $\pm 100$ nA
<b>Resolution (at each range)</b>	31.3 $\mu$ A, 3.13 $\mu$ A, 313 nA, 31.3 nA, 3.13 nA, 313 pA, 31.3 pA, 3.13 pA
<b>Accuracy</b>	$\pm 0.2\%$ of setting; $\pm 0.05\%$ of range
<b>DAC Output</b>	16 bits
<b>POWER AMPLIFIER (COUNTER ELECTRODE AMPLIFIER)</b>	
<b>Output Current</b>	$\pm 1.0$ A (maximum)
<b>Short Circuit Current Limit</b>	1 A, 100 mA ranges: < 1.3 A 10 mA – 100 nA ranges: < 200 mA
<b>Compliance Voltage</b>	> $\pm 17$ V
<b>Bandwidth</b>	> 2.5 MHz (on fastest speed setting)
<b>Noise and Ripple</b>	< 35 $\mu$ V <sub>RMS</sub> in 2 MHz bandwidth
<b>Slew Rate/Rise Time</b>	10 V/ $\mu$ sec (on fastest speed setting)
<b>ELECTROMETER (REFERENCE ELECTRODE AMPLIFIER)</b>	
<b>Input Impedance</b>	> $10^{12}$ $\Omega$ in parallel with < 10 pF
<b>Input Current</b>	< 10 pA leakage/bias current at 25°C
<b>CMRR</b>	> 100 dB 0 – 1 kHz > 80 dB $\leq$ 10 kHz > 60 dB $\leq$ 100 kHz > 40 dB $\leq$ 1 MHz
<b>Bandwidth</b>	> 15 MHz (3 dB)

(specifications table is continued on the next page)

<b>MEASURED POTENTIAL</b>	
<b>Ranges</b>	$\pm 15.0$ V, $\pm 10.0$ V, $\pm 2.5$ V
<b>Resolution (at each range)</b>	469 $\mu$ V, 313 $\mu$ V, 78 $\mu$ V per DAC bit
<b>Accuracy</b>	$\pm 0.2\%$ of setting, $\pm 0.05\%$ of range
<b>ADC Input</b>	16 bits
<b>Filters</b>	10 Hz, 30 Hz, 100 Hz, 1 kHz, 10 kHz (2-pole, low pass Bessel filters)
<b>APPLIED POTENTIAL (POTENTIOSTATIC MODE)</b>	
<b>Ranges</b>	$\pm 15.0$ V, $\pm 10.0$ V, $\pm 2.5$ V
<b>Resolution (at each range)</b>	469 $\mu$ V, 313 $\mu$ V, 78 $\mu$ V per DAC bit
<b>Accuracy</b>	$\pm 0.2\%$ of setting, $\pm 0.05\%$ of range
<b>DAC Output</b>	16 bits
<b>CV Sweep Rate (min)</b>	10 $\mu$ V/s (469 $\mu$ V step per 46.9 s, 313 $\mu$ V step per 31.3 s, or 78 $\mu$ V per 7.8 s)
<b>CV Sweep Rate (max)</b>	75 V/s
<b>DATA ACQUISITION (FOR DC EXPERIMENTS)</b>	
<b>Clock Resolution</b>	10 ns (minimum time base)
<b>Point Interval*</b>	80 $\mu$ s (minimum)
<b>Synchronization</b>	Simultaneous sampling of all analog input signals
<b>Raw Point Total</b>	< 10 million per experiment
<b>ROTATOR CONTROL CONNECTIONS (BACK PANEL)</b>	
<b>Connector A</b>	7-pin mini circular DIN includes analog and digital signal grounds, digital rotator enable signal (+15 V max), auxiliary digital output signal, and analog rotation rate control signal
<b>Connector B</b>	3-pin connector includes analog signal ground, digital rotator enable signal (+15 V max), and analog rotation rate control signal
<b>Rate Control Signal</b>	$\pm 10.0$ V, $\pm 2.5$ V
<b>Digital Enable Signal</b>	Open drain with 4.7 k $\Omega$ pull up to +5 V (TTL compatible)
<b>ACCESSORIES</b>	
<b>Dummy Cell</b>	External dummy cell (included)
<b>Cell Cable</b>	Combination D-SUB connector to multiple banana plugs via shielded coaxial cables (included)

(specifications table is continued on the next page)

<b>AUXILIARY CONNECTIONS (BACK PANEL)</b>	
<b>Connector C</b>	9-pin DSUB connector that includes DC Common, two digital output signals, and two digital input signals
<b>Trigger Input</b>	BNC female, TTL compatible
<b>Trigger Output</b>	BNC female, TTL compatible
<b>K1 Input and K2 Input</b>	BNC female, $\pm 10$ V differential input, 20 k $\Omega$ impedance, $\pm 0.5\%$ accuracy; allows external waveform to be summed directly to the working electrode excitation signal
<b>E1 Output</b>	BNC female, $\pm 15$ V, $\pm 10$ V, $\pm 2.5$ V output, $\pm 0.5\%$ accuracy
<b>I1 Output</b>	BNC female, $\pm 10$ V output, scaled to current range, $\pm 0.5\%$ accuracy
<b>E2 Output</b>	BNC female, $\pm 15$ V, $\pm 10$ V, $\pm 2.5$ V output, $\pm 0.5\%$ accuracy
<b>I2 Output</b>	BNC female, $\pm 10$ V output, scaled to current range, $\pm 0.5\%$ accuracy
<b>Auxiliary Analog Input</b>	BNC female, $\pm 10$ V differential input, 313 $\mu$ V resolution, 0.2% accuracy (available when second working electrode not in use)
<b>Auxiliary Analog Output</b>	BNC female, $\pm 10$ V bipolar output, 313 $\mu$ V resolution, 0.2% accuracy (available when second working electrode not in use)
<b>GENERAL SPECIFICATIONS</b>	
<b>Power Required</b>	24.0 VDC ( $\pm 5\%$ ), 5.0 A (low voltage DC device)
<b>Power Supply</b>	Input Requirements: 100 to 240 VAC, 1.4 to 0.7 A, 50 to 60 Hz Output Power: 24 VDC, 5.0 A Power supply (included) has a C14 type input connector
<b>Power Cord</b>	Various international cables sold separately (C13 type)
<b>LED Indicators</b>	Power, USB, and status
<b>Instruments Dimensions</b>	160 $\times$ 324 $\times$ 255 mm (6.3 $\times$ 12.75 $\times$ 10.0 in)
<b>Instrument Weight</b>	4.6 kg (10.2 lb)
<b>Shipping Dimensions</b>	254 $\times$ 356 $\times$ 457 mm (10 $\times$ 14 $\times$ 18 in)
<b>Shipping Weight</b>	7.7 kg (17 lb)
<b>Temperature Range**</b>	10°C to 40°C
<b>Humidity Range</b>	80% RH maximum, non-condensing

\* Data acquisition using the minimum point interval is possible for short-duration bursts. The burst duration depends upon the available host PC USB bandwidth and is typically at least 3 s.

\*\* It is recommended that the instrument primarily be used at or around room temperature (25°C). Varying operational temperature may affect accuracy.

§ The "practical range" of measurable currents goes from the maximum current output of the amplifier down to the current level at which noise begins to interfere with the signal. Using proper grounding, a cell shielded by a Faraday cage, and coaxial cell cables, it is possible to routinely measure signals as low as 5 pA.

## 2.4 Standard Electrochemical Methods

The WaveDriver 40 bipotentiostat together with the AfterMath software package can perform many electrochemical techniques (see Table 2-1). Further descriptions about how to configure and execute these techniques can be found in AfterMath software documentation.

<b>Simple Methods</b>	<b>Rotating Disk Methods</b>
Open Circuit Potential (OCP)	Rotating Disk Electrode (RDE)
Constant Potential Electrolysis (BE)	Koutecky-Levich Series (KL-RDE)
Constant Current Electrolysis (BE)	Rotating Disk Electrolysis (BE-RDE)
Zero Resistance Ammeter (ZRA)	Rotating Disk Chronopotentiometry (CP-RDE)
<b>Voltammetric Methods</b>	Rotating Disk Ramp Chronopotentiometry (RCP-RDE)
Cyclic Voltammetry (CV)	<b>Rotating Ring-Disk Methods</b>
Linear Sweep Voltammetry (LSV)	Rotating Ring-Disk Voltammetry (RRDE)
Staircase Voltammetry (SCV)	Rotating Ring-Disk Koutecky-Levich (KL-RRDE)
Chronoamperometry (CA)	Rotating Ring-Disk Electrolysis (BE-RRDE)
Normal Pulse Voltammetry (NPV)	<b>Corrosion Methods</b>
Cyclic Step Chronoamperometry (CSCA)	Linear Polarization Resistance (LPR)
Differential Pulse Voltammetry (DPV)	Rotating Cylinder Voltammetry (RCE)
Square-Wave Voltammetry (SWV)	Rotating Cylinder Electrolysis (BE-RCE)
Double Potential Step Chronoamperometry (DPSCA)	Rotating Cylinder Eisenberg Study (EZB-RCE)
<b>Galvanostatic Methods</b>	Rotating Cylinder Polarization Resistance (LPR-RCE)
Chronopotentiometry (CP)	Rotating Cylinder Open Circuit Potential (OCP-RCE)
Ramp Chronopotentiometry (RCP)	Rotating Cylinder Chronopotentiometry (CP-RCE)
Staircase Potentiometry (SCP)	Rotating Cylinder Ramp Chronopotentiometry (RCP-RCE)
Cyclic Step Chronopotentiometry (CSCP)	<b>Uncompensated Resistance Methods</b>
<b>Dual Electrode Methods</b>	Current Interrupt (CI-RU)
Dual Electrode Electrolysis (DEBE)	Positive Feedback (PF-RU)
Dual Electrode Voltammetry (DECV)	<b>Stripping Voltammetry</b>
<b>Spectroscopic Methods*</b>	Anodic & Cathodic Stripping Voltammetry (ASV)
Spectroscopy (SPEC)	Differential Pulse Stripping Voltammetry (DPSV)
Spectroelectrochemistry (SPECE)	Square-Wave Stripping Voltammetry (SWSV)

**Table 2-1. Electrochemical Techniques in AfterMath**

\*Access to these electrode methods requires a separate software license. If you have an Avantes spectrometer and would like to access these experiments, please contact Technical Service for assistance (see Section 1.6).



**TIP:**

**More information about configuring electrochemical techniques using AfterMath may be found by searching our knowledgebase.**

<https://www.pineresearch.com/shop/knowledgebase/>

## 2.5 System Components

The WaveDriver 40 bipotentiostat system, as shipped from the production facility, includes all parts, cables, and software necessary for its initial use (see Table 2-2).





		
		
		
<b>1 Instrument</b>	WaveDriver 40 Bipotentiostat/Galvanostat	
<b>2 USB Flash Drive</b>	Contains AfterMath software, drivers, and license files	
<b>3 Cell Cable</b>	General purpose cell cable with six coaxial electrode cables and one instrument chassis connector (see Section 5 for details)	
<b>4 Pine Research Universal Dummy Cell</b>	A network of test circuits used to verify proper instrument operation (see Section 2.8 for details)	
<b>5 Power Supply</b>	Input Requirements: 100 to 240 VAC, 1.4 to 0.7 A, 50 to 60 Hz Output Power: 24 VDC, 5.0 A Power supply (included) has a C14 type input connector compatible with a variety of international power cords (sold separately, see Section 7)	
<b>6 Interface (USB) Cable</b>	Communication cable between computer and WaveDriver 40 (USB type A male to type B male)	

Table 2-2. Main Components Included with WaveDriver 40 Bipotentiostat





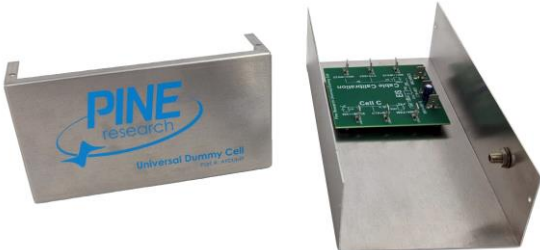

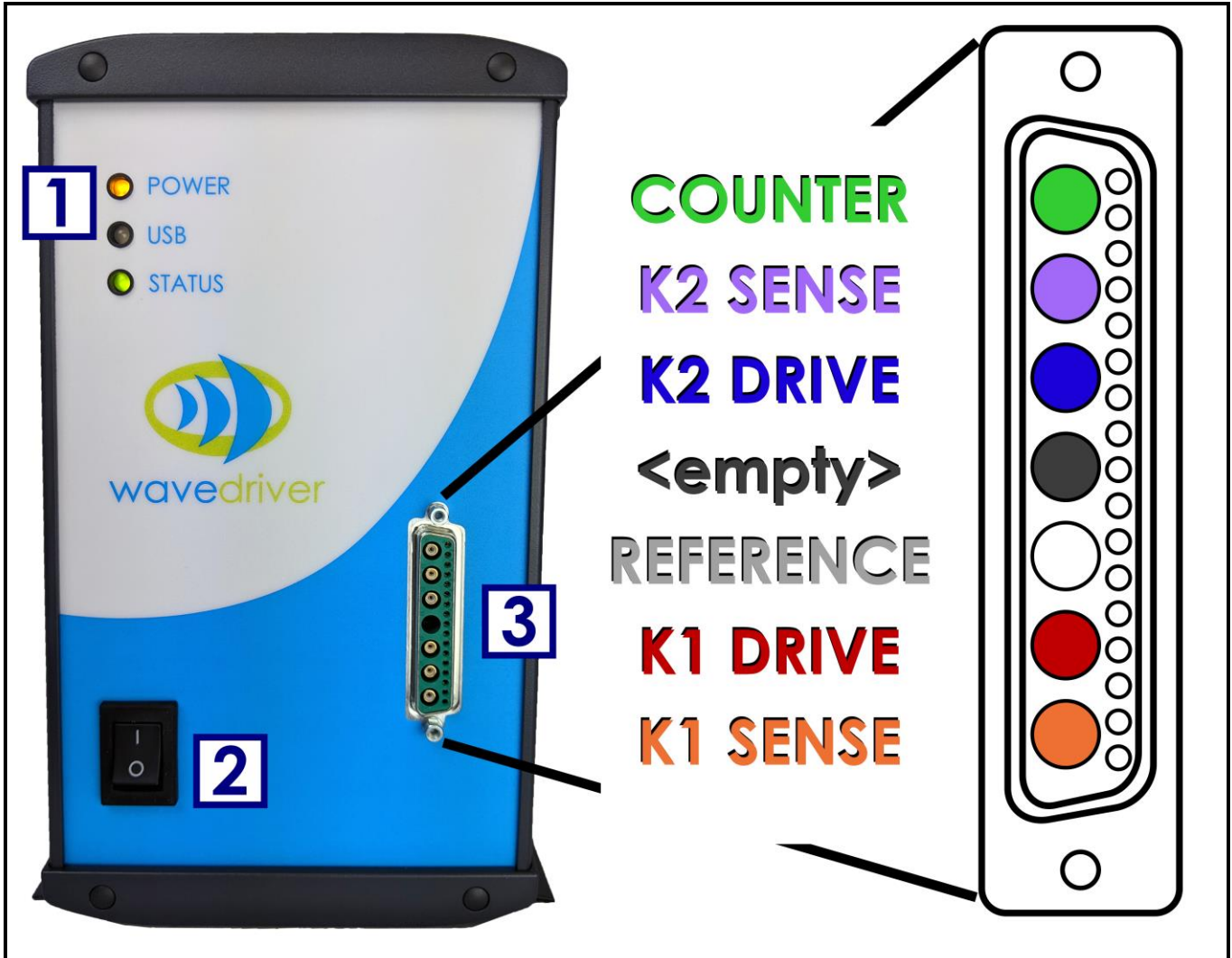
## 2.6 Front Panel

The front panel of the WaveDriver 40 has three LED indicators, the power switch, and the cell cable port (see Table 2-3). The three LEDs indicate power, communications activity (USB), and overall instrument status. Various colors and blink patterns are used by the LED indicators (see Table 2-4).

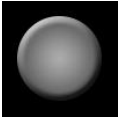
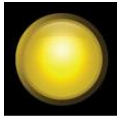

1	<b>LED Indicator Lights</b>	LEDs indicate status of the instrument
2	<b>Power Switch</b>	Controls whether power is "on" (I) or "off" (O)
3	<b>Cell Cable Port</b>	Provides connection between instrument and cell cable

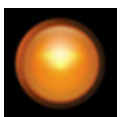
Table 2-3. Front Panel of the WaveDriver 40 Bipotentiostat

LED	LED Color/State	Indication
Power	 not illuminated	When the power LED is not illuminated, the instrument power switch is in the "off" position (or the power supply is not providing power).
	 solid yellow	When the power LED is solid yellow, the power supply is providing power to the instrument and the power switch is in the "on" position.
USB	 blinking green	When the USB LED is blinking (or flickering), data transfer is occurring between the instrument and the computer.
	 not illuminated	When the USB LED is not illuminated, no data is being transferred between the instrument and computer.
Status	 slow blinking green	When the status LED is green and blinking slowly (one second illuminated, one second not illuminated), successful communication has occurred between the instrument and the AfterMath software, and the instrument is presently idle ( <i>i.e.</i> , not performing an experiment).
	 fast blinking green	When the status LED is green and blinking quickly (half second illuminated, half second not illuminated), the instrument is performing an experiment.
	 blinking orange	When the status LED is orange and blinking, the instrument is performing a self-test (immediately after being powered on), or the instrument is waiting for the AfterMath software to establish initial communication with the instrument.
	 solid or blinking red	When the status LED is red (either blinking or solid), there is a serious problem with the instrument. Contact Technical Service for assistance (see Section 1.6).

**Table 2-4. Overview of WaveDriver 40 Bipotentiostat LED Indicator Lights**



## 2.7 Back Panel

The back panel of the WaveDriver 40 features several input and output connections to facilitate connection to other instruments and devices (see Figure 2-1 and Table 2-5 below). Pinouts for the three control ports (labeled “A”, “B”, and “C” in the “CONTROL PORTS” box on the back panel – see Figure 2-1) are also provided (see Figure 2-2). Control ports A and B are specifically designed to control an electrode rotator, while control port C is a non-specific digital control port.

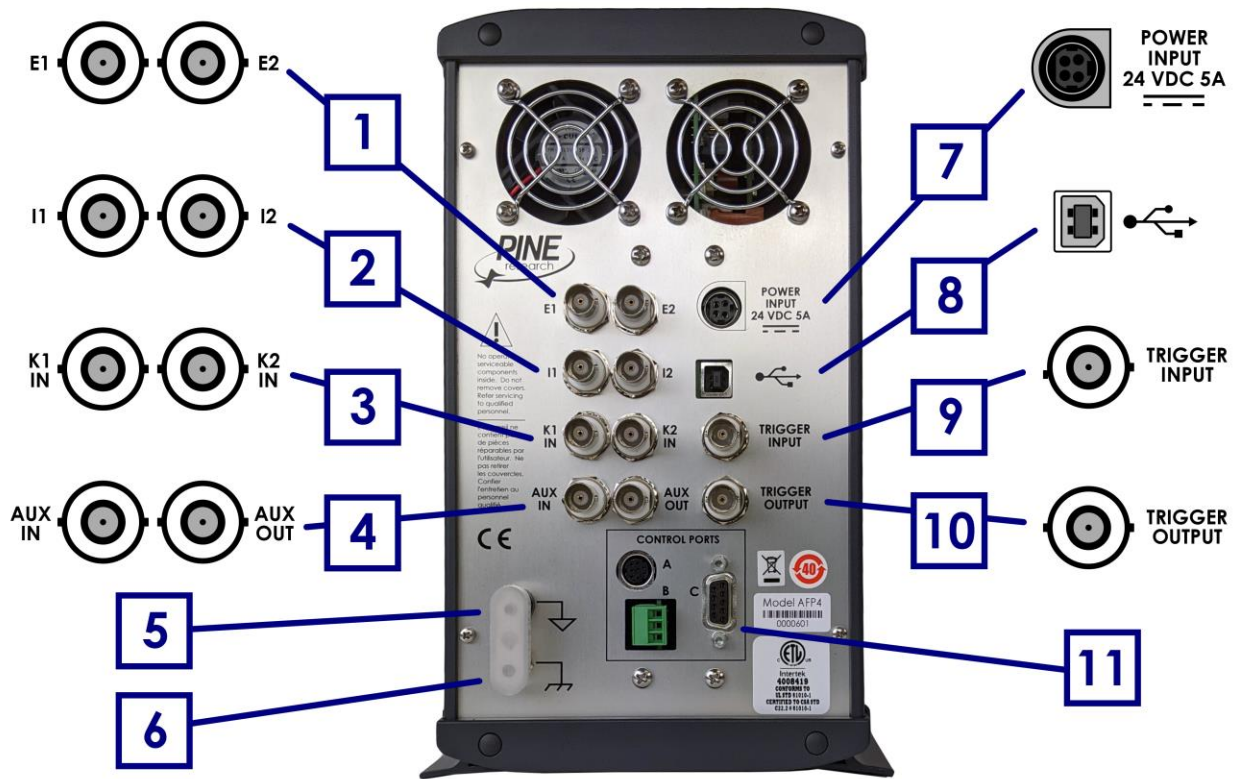

Figure 2-1. WaveDriver 40 Back Panel Connections



1	<b>E1</b>	BNC female, potential output from first working electrode (K1)
	<b>E2</b>	BNC female, potential output from second working electrode (K2)
2	<b>I1</b>	BNC female, current output from first working electrode (K1)
	<b>I2</b>	BNC female, current output from second working electrode (K2)
3	<b>K1 IN</b>	BNC female, $\pm 10$ V differential input, 20 k $\Omega$ impedance, $\pm 0.5\%$ accuracy; sums an external waveform to first working electrode (K1)
	<b>K2 IN</b>	BNC female, $\pm 10$ V differential input, 20 k $\Omega$ impedance, $\pm 0.5\%$ accuracy; sums an external waveform to the second working electrode (K2)
4	<b>AUX IN</b>	BNC female, $\pm 10$ V differential input, 313 $\mu$ V resolution, 20 k $\Omega$ impedance, 0.2% accuracy; available only when K2 electrode not in use
	<b>AUX OUT</b>	BNC female, $\pm 10$ V bipolar output, 313 $\mu$ V resolution, 0.2% accuracy; available only when K2 electrode not in use
5	<b>DC Common Terminal</b>	 Banana jack (black) that provides a secure connection to DC Common (signal ground)
6	<b>Chassis Terminal</b>	 Banana jack (metal) that provides a secure connection to the chassis of the instrument
7	<b>Power Input</b>	A low voltage (24.0 VDC, 5.0 A) power input connector
8	<b>USB Input</b>	USB jack (type B) for computer communication
9	<b>Trigger Input</b>	BNC female, TTL compatible
10	<b>Trigger Output</b>	BNC female, TTL compatible
11	<b>Rotator Control Port A</b>	7-pin mini-DIN input for rotator control – includes analog and digital signal grounds, digital rotator enable signal (+15 V max), auxiliary digital output signal, and analog rotation rate control signal
	<b>Rotator Control Port B</b>	3-pin terminal block connector for rotator control – includes analog signal ground, digital rotator enable signal (open drain – TTL compatible, +15 V max), and analog rotation rate control signal ( $\pm 10$ V, $\pm 2.5$ V)
	<b>Digital Port C</b>	9-pin D-Sub connector that includes digital signal ground, two digital output signals, and two digital input signals

Table 2-5. WaveDriver 40 Back Panel Connector Descriptions



Pin	Signal	Pin	Signal
A1	Unused	B3	Digital rotator enable signal
A2	Auxiliary digital output signal	C1	Unused
A3	Unused	C2	Digital signal input 2
A4	Analog rotation rate control signal	C3	Digital signal input 3
A5	Digital signal ground	C4	Digital signal output 2
A6	Unused	C5	Digital signal output 3
A7	Digital rotator enable signal	C6	+5 V digital output
A8	Analog signal ground	C7	Digital signal ground
B1	Analog rotation rate control signal	C8	Digital signal ground
B2	Analog signal ground	C9	Digital signal ground

Figure 2-2. WaveDriver 40 Control Ports A, B, and C Pinouts

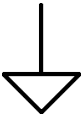
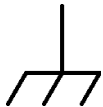
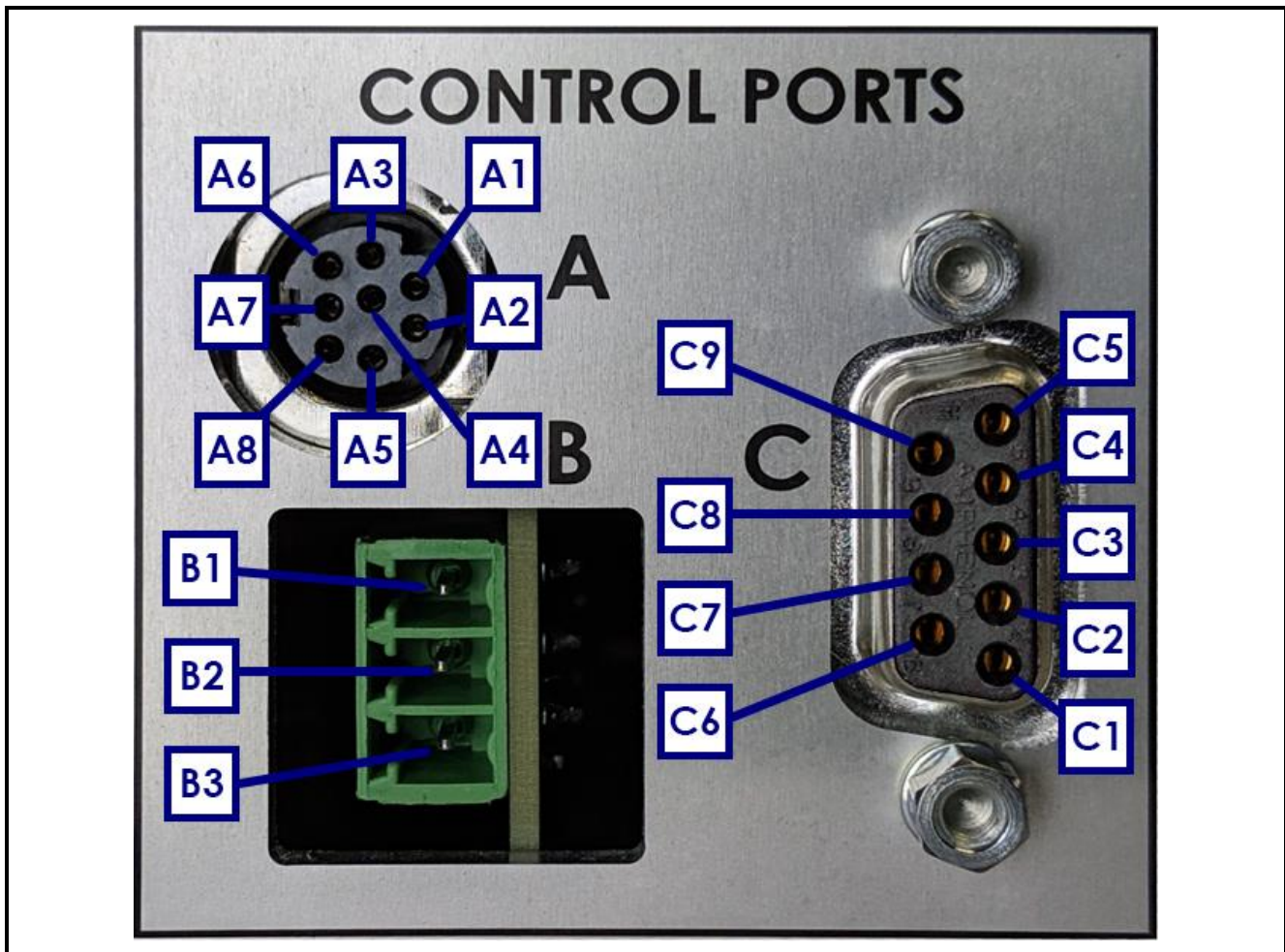
## 2.8 Dummy Cell Description

A dummy cell is a network of known resistors, capacitors, and inductors that can be used to test a potentiostat to ensure that it is working properly. The Pine Research Universal Dummy Cell included with the WaveDriver 40 contains three separate circuit networks, though two are not used (see Figure 2-3).

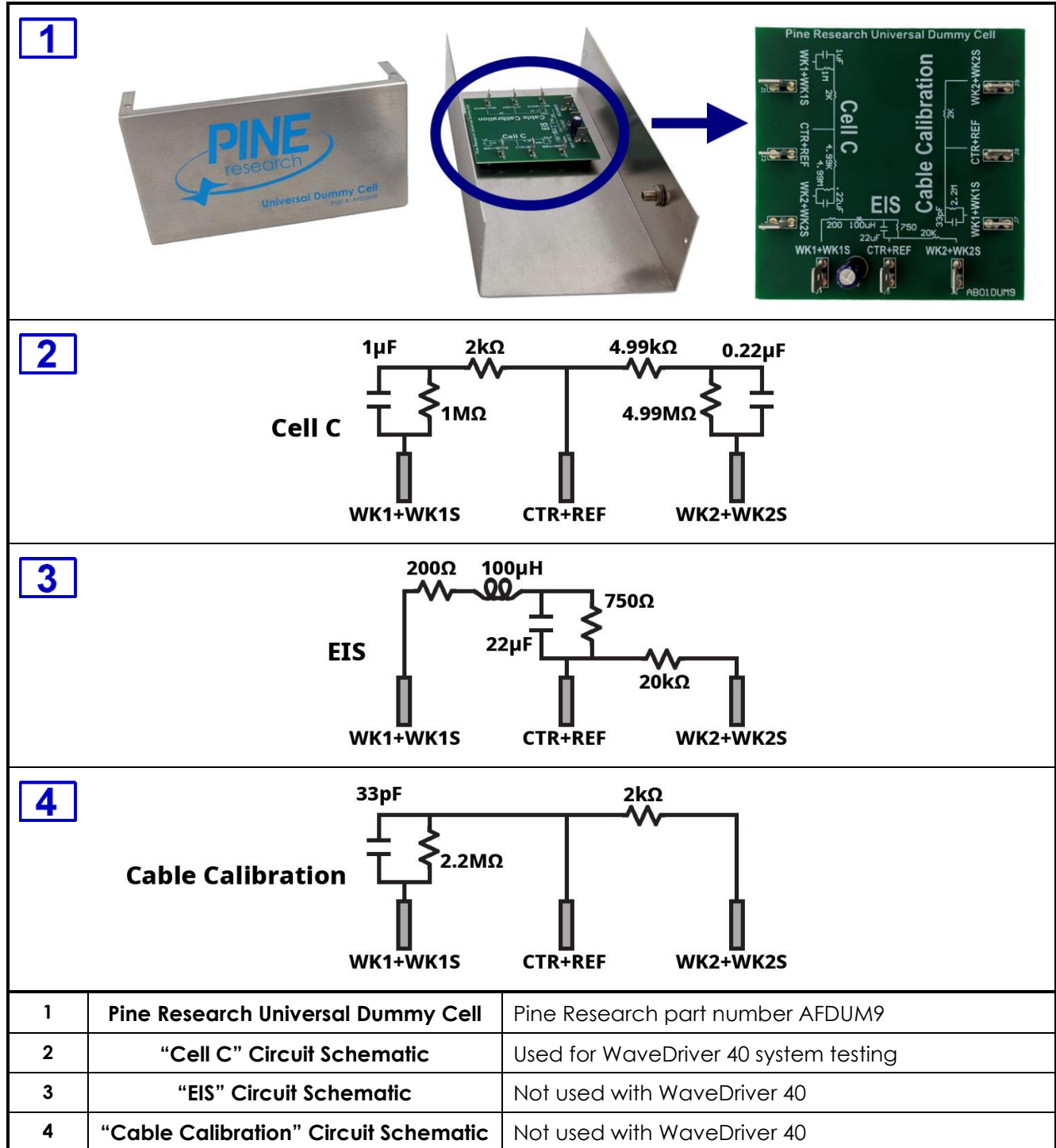

Figure 2-3. WaveDriver 40 Pine Research Universal Dummy Cell (with Schematic Diagrams)

The circuit for "Cell C" of the dummy cell is used for testing the capabilities of the WaveDriver 40. The circuits for both "EIS" and "Cable Calibration" are not used in conjunction with the WaveDriver 40, and may be disregarded.

**NOTE:**

If using a WaveDriver 40 purchased before November 2020, a different dummy cell was included (Pine Research part number AFDUM3). See Section 9 for information on this legacy dummy cell.

**TIP:**

Contact Technical Service for assistance if you have any questions or concerns regarding the use of the Pine Research Universal Dummy Cell (see Section 1.6).

## 3. System Installation

Setting up the WaveDriver 40 system in a laboratory consists of three basic steps: (1) physical installation, (2) software installation, and (3) system testing. The entire process usually requires about sixty minutes. The physical and software installation steps are described in this section (below), and the system testing procedures are described in the next section (see Section 4).

### 3.1 Physical Installation

The WaveDriver 40 is a benchtop instrument designed for use in a typical laboratory environment. Physical installation involves positioning the instrument and the computer that controls the instrument in a suitable location and connecting the instrument to a source of electrical power (*i.e.*, the AC Mains) and to the computer via a USB cable.

#### 3.1.1 Location

The instrument should be placed on a sturdy lab bench or table in such a way that there is unobstructed access to the instrument's front panel; this ensures space for the cell cable connection and allows the user to easily operate the power switch and see the LED lights. There should also be at least two inches (50 mm) of clearance around the sides (left, right, and back) and above (top) the instrument. Particular care should be given to selecting a clean and dry location. The vent fans on the back panel must not be blocked so that adequate ventilation is available for cooling the circuitry inside the instrument.

During normal use, the instrument is connected to an electrochemical cell via a cell cable plugged into the front panel of the instrument. Thus, it is important to ensure that the lab bench or table also has sufficient workspace for securely mounting the electrochemical cell and for routing the cell cable between the instrument and the electrochemical cell.

#### 3.1.2 Glovebox Installation

There are two practical ways to perform electrochemical experiments inside of a glovebox. Both require that the glovebox be equipped with special cable feedthroughs.

**Potentiostat and Electrochemical Cell in Glovebox.** Placing the instrument and the electrochemical cell inside the glovebox is by far the easiest and preferred approach. By keeping the instrument close to the cell, the cell cables are shorter, minimizing interference from environmental noise sources. A special USB feedthrough port is required for this approach. This allows the computer controlling the instrument to remain outside the glovebox with only the USB communication signals passing through the wall of the glovebox. Inexpensive third-party USB cable feedthroughs are available (see Figure 3-1) that fit into the standard KF-style flanges commonly found on gloveboxes. Many Pine Research customers have successfully used feedthroughs offered by the Kurt J. Lesker Company ([www.lesker.com](http://www.lesker.com)).

The instrument may be transferred into the glovebox by passing it through the glovebox antechamber. Any cables, power cords, or instrument accessories are also safe to bring into the glovebox through the antechamber. When ramping the antechamber down to vacuum, a gradual approach should be taken to prevent damage to instrument circuitry. The exact time needed to fully remove any residual air from the potentiostat and accessories varies by antechamber size and vacuum strength. While it is recommended to follow established glovebox user protocols, it is also suggested that the amount of time the instrument is exposed to vacuum be as short as possible. Once inside the glovebox, operation of the potentiostat is identical to outside the glovebox, though some signal noise may be introduced by the glovebox environment (vacuum pumps, gas valve actuators, vibrations, etc.). Once the instrument



is placed inside the glovebox, it is a good idea to leave it in the glovebox; repeated cycling through the antechamber is not recommended.

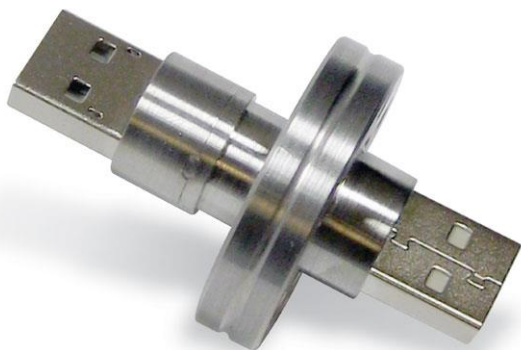

Copyright © Kurt J. Lester Company. Used with permission.



**Figure 3-1. USB Cable Glovebox Feedthrough**



**Figure 3-2. Cell Cable Glovebox Feedthrough**

**Electrochemical Cell Only in Glovebox.** If the potentiostat must remain outside the glovebox, then it is possible to feed a longer version of the cell cable through a port in the wall of the glovebox. A port with a KF-40 flange is ideal, and epoxy can be used to seal around the individual cell cable lines as they pass through the flange (see Figure 3-2). To mitigate any signal noise picked up by the longer cell cable, an electrically conductive and earth grounded mesh may need to be installed around the cell cable bundle.

### 3.1.3 Connecting the Power Supply to the Instrument



**Figure 3-3. Power Supply with Low Voltage (24 VDC) Cable Connection to Back Panel**

The power supply provides the DC power required by the instrument (24 VDC, 5.0 A) via a low voltage cable. One end of the low voltage cable is permanently connected to the power supply, and the other end is connected to the POWER INPUT port located on the back panel of the instrument (see Figure 3-3).



**CAUTION:**

**Use proper cable connector orientation.**

**One side of the low voltage cable connector has a flat surface. When inserting this connector into the POWER INPUT port, the flat surface of the connector must be oriented toward the right (i.e., towards the words "POWER INPUT" printed on the back panel)**

**ATTENTION:**

*Utilisez l'orientation convenable du câble connecteur.*

*Un côté du câble connecteur basse tension a une surface plane. Lors de l'insertion de ce connecteur dans le port d'alimentation (POWER INPUT), la surface plane du connecteur doit être orientée vers la droite (c'est-à-dire vers les mots "POWER INPUT" imprimés sur le panneau arrière).*

When connecting the low voltage power cable to the POWER INPUT port on the back panel, take note that the connector will only fit into the port using one particular orientation. The side of the cable connector that is completely flat must be oriented to the right when plugging the connector into the port.

When properly installed, the low voltage power cable will securely latch into the POWER INPUT port. When unplugging the low voltage power cable from the port, it is important to release this latch correctly. Grip the connector firmly near the flat part of the connector. Then, pull the connector straight out (do not twist the connector).

### 3.1.4 Connecting the Power Supply to the AC Mains

The WaveDriver 40 power supply is connected to the AC Mains via an AC power cord. The AC power cord must be rated to carry at least 10 Amps. One end of the AC power cord is connected to the standard C14 connector on the power supply, and the other end is connected to the AC Mains (wall outlet). Pine Research offers power cords suitable for use in a variety of different countries and regions (see Section 7).

The local source of electrical power (*i.e.*, the AC Mains) must be a branch circuit protected by a circuit breaker rated between 10 and 15 Amps. The AC voltage supplied by the AC Mains must be between 100 and 240 VAC, and the AC frequency must be between 50 and 60 Hz. The power supply and AC power cord must be positioned such that the user has unobstructed access to these items. The user must be able to disconnect the instrument from the power supply and disconnect the power supply from the AC mains (wall outlet) without any obstructions.

**CAUTION:**

**Connect the Power Supply to the AC mains using the Power Cord supplied with the WaveDriver 40 and certified for the country of use (see Section 7 of this User Guide for more details).**

**ATTENTION:**

*Connectez le bloc d'alimentation au secteur à l'aide du cordon d'alimentation fourni avec l'appareil WaveDriver 40 et conforme aux réglementations du pays d'utilisation (pour plus de détails, consultez la partie 7 du présent mode d'emploi).*

**CAUTION:**

**Do not block access to the Power Supply or its cord. The user must have access to disconnect the Power Supply or the Power Cord from the AC mains at all times.**

**ATTENTION:**

*Ne bloquez pas l'accès au bloc d'alimentation ou son cordon. L'utilisateur doit être en mesure de déconnecter le bloc d'alimentation ou le cordon d'alimentation du secteur à tout moment.*

**CAUTION:**

**The Power Switch located on the front panel of the instrument disconnects the instrument from the power source. Do not block access to the Power Switch. The user must have access to the Power Switch at all times.**

**ATTENTION:**

*L'interrupteur d'alimentation situé sur le devant de l'appareil permet de couper l'alimentation. Ne bloquez pas l'accès à l'interrupteur. L'utilisateur doit avoir accès à l'interrupteur à tout moment.*



## 3.2 AfterMath Software Installation



### STOP:

**Do not use the USB cable to connect the WaveDriver 40 to the computer until after the software and driver installation are complete. It is important to first install AfterMath and the associated device driver software so that Microsoft Windows can properly detect the instrument.**

AfterMath is a software package designed to run on a personal computer using the Windows® operating system. The minimum system requirements for the personal computer and operating system are listed below (see Table 3-1).

<b>Processor Speed</b>	1 GHz (32-bit or 64-bit processor) minimum
<b>Physical Memory</b>	2 GB minimum recommended RAM; 4 GB minimum (for 32-bit processor) or 6 GB (for 64-bit processor) preferred
<b>Screen Resolution</b>	1024 x 768 pixels or greater required
<b>Operating System</b>	Windows 7 (32 or 64 bit), Windows 8 (32 or 64 bit), Windows 10 (32 or 64 bit)
<b>USB Port</b>	USB 2.0 must be available
<b>Prerequisite Software</b>	Microsoft .NET Framework (version 4.0) Microsoft Visual C++ Runtime Library (version 8.0)

**Table 3-1. Computer System Requirements for AfterMath Software**

Note that the prerequisite software (Visual C++ runtime and .NET Framework) is often already present on modern personal computers. If they are missing from the computer, these components are available for free download from the Microsoft website. Up-to-date AfterMath and Microsoft Corporation download links are maintained on the Pine Research knowledgebase website.



### TIP:

**The most up-to-date versions of the software required to operate the WaveDriver 40 instrument may be found on the Pine Research knowledgebase at the following address:**

<https://www.pineresearch.com/shop/knowledgebase/>

### 3.2.1 Step-by-Step Software Installation Instructions

AfterMath installation media is included with the WaveDriver 40. The installation media contains the latest release of AfterMath available at the time of purchase, the device drivers for communicating with the instrument, and the permissions files that implement the software license.

The installation media contains a file called "**setup.exe**". Launch this executable file and follow the instructions on the screen. Screenshots of a typical installation are provided below (see Figure 3-4 through Figure 3-14).

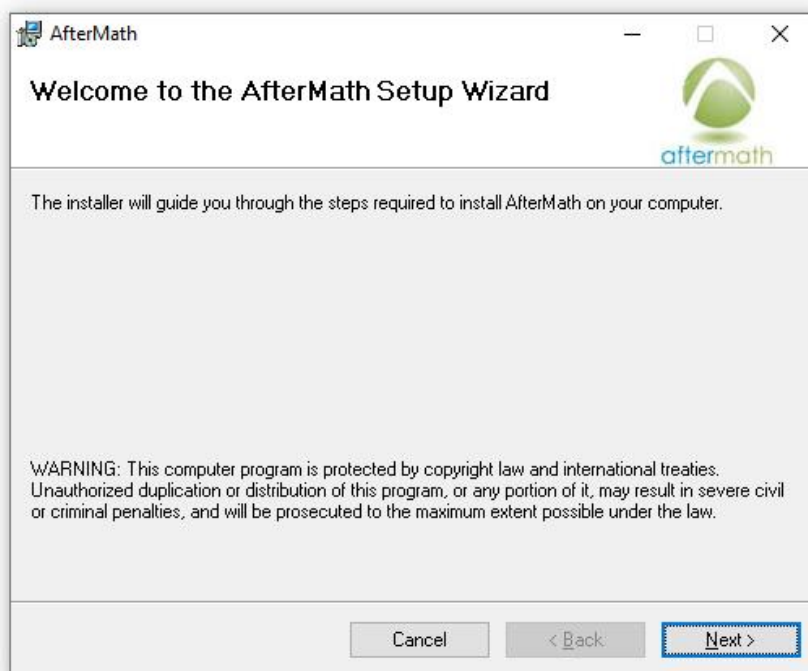

Figure 3-4. Welcome to AfterMath Setup Wizard Dialog Box

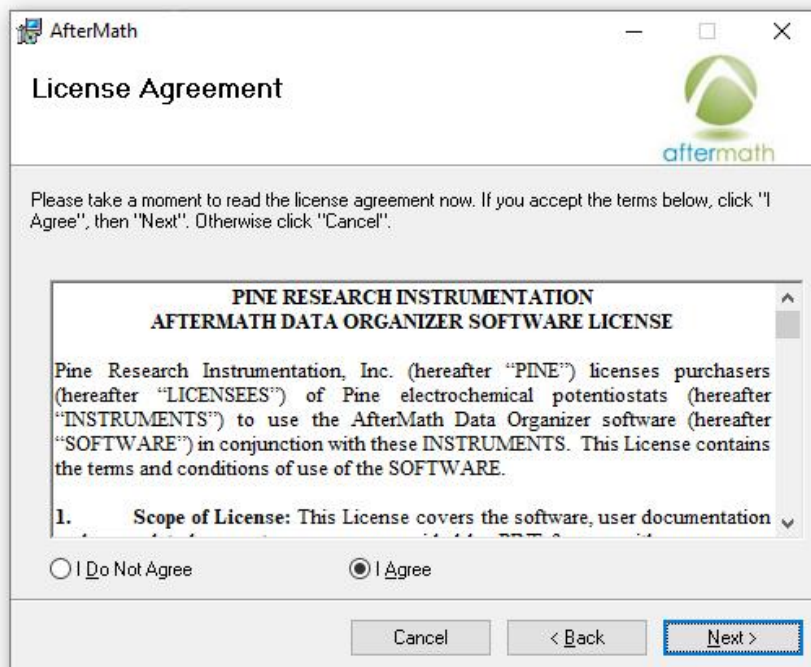

Figure 3-5. AfterMath Installation License Agreement

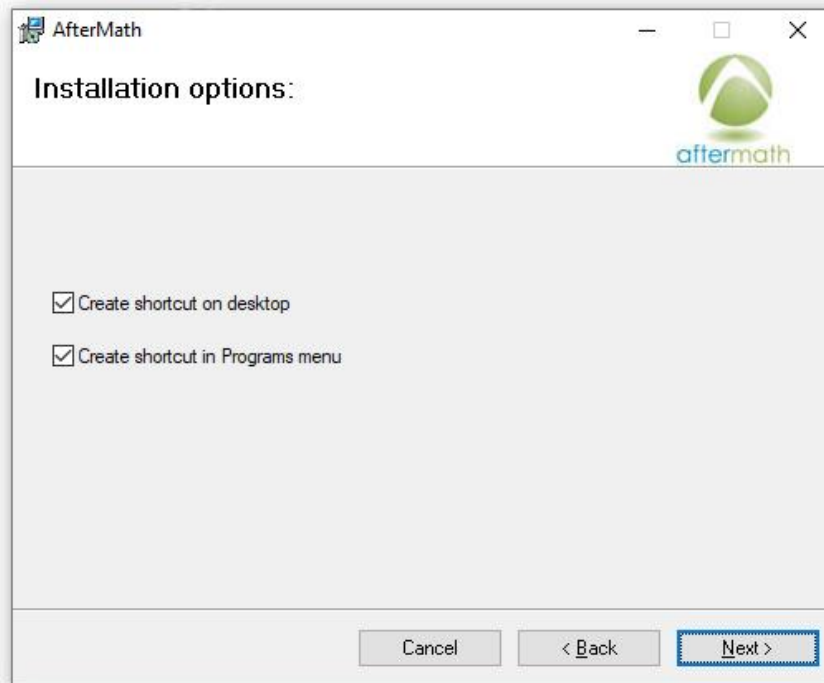

Figure 3-6. AfterMath Installation Options

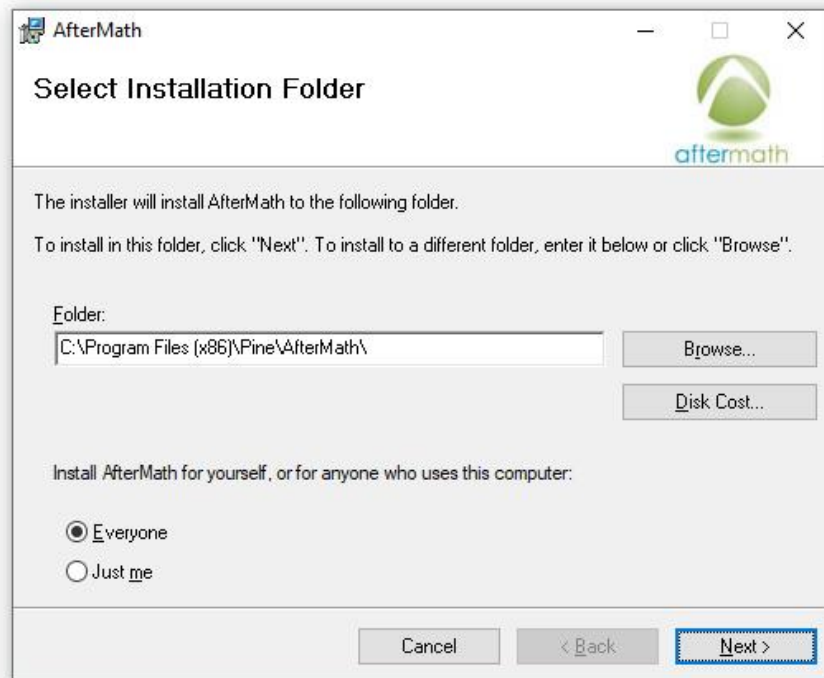

Figure 3-7. Selecting AfterMath Installation Folder and User Access

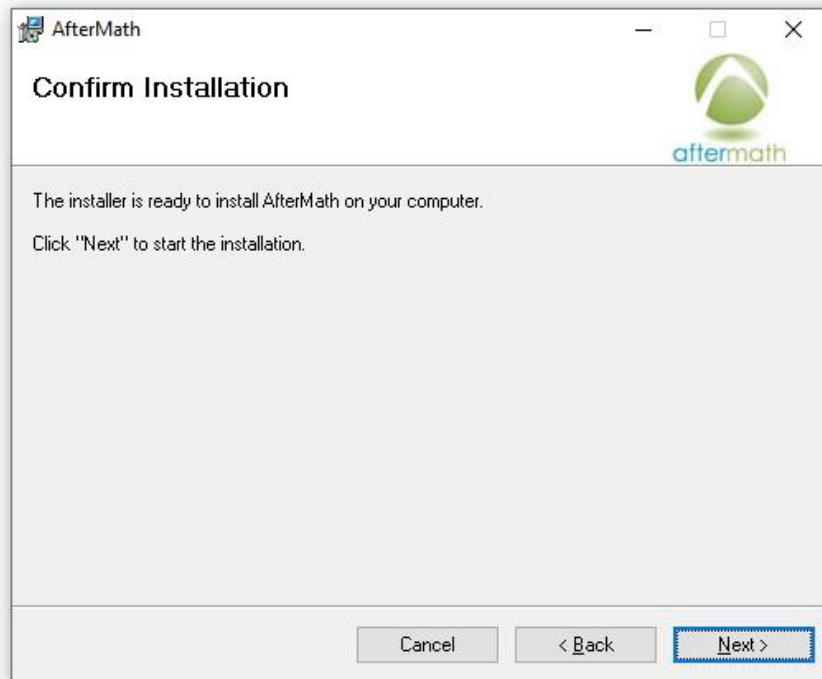

Figure 3-8. Confirm Installation of AfterMath

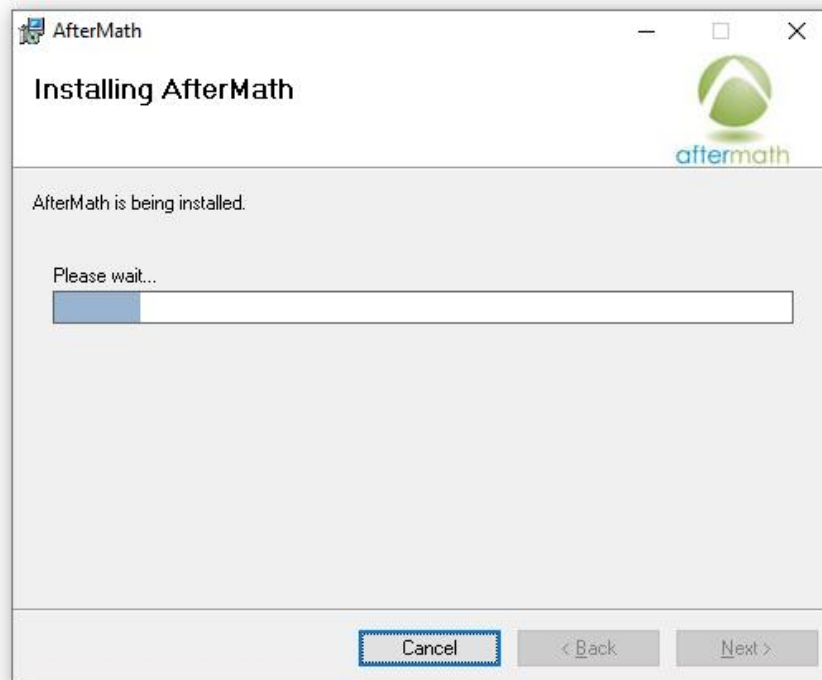

Figure 3-9. Installation Progress of AfterMath



Figure 3-10. Device Driver Installation Wizard

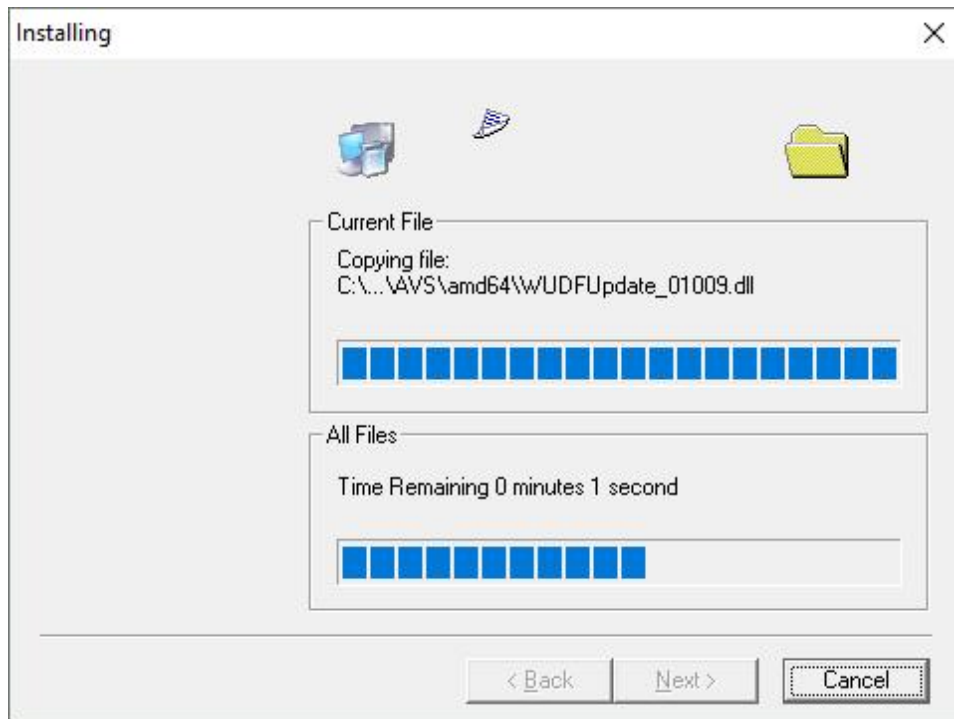

Figure 3-11. USB/Device Driver Installation Progress

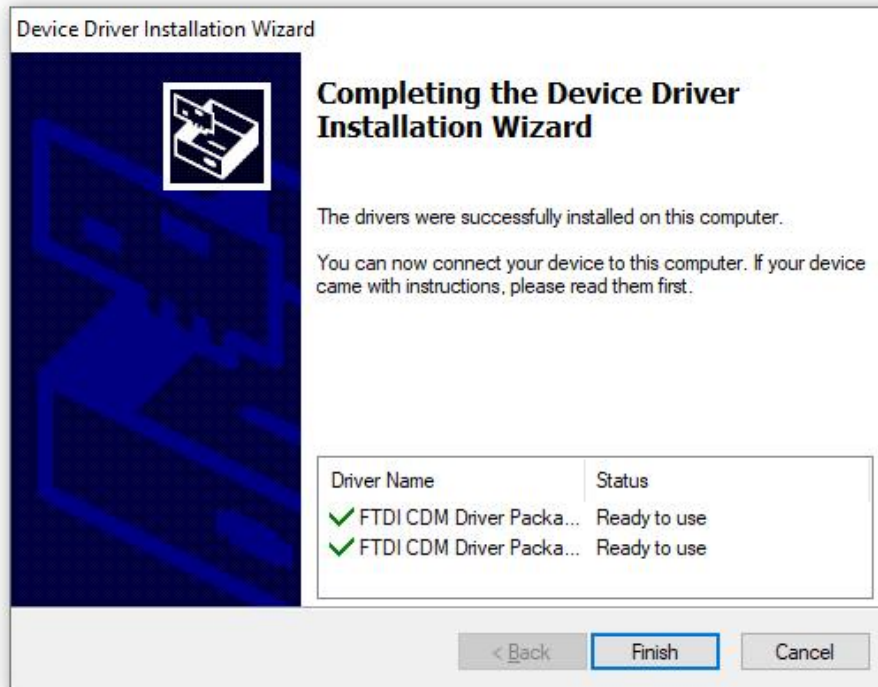

Figure 3-12. USB/Device Driver Installation Completion

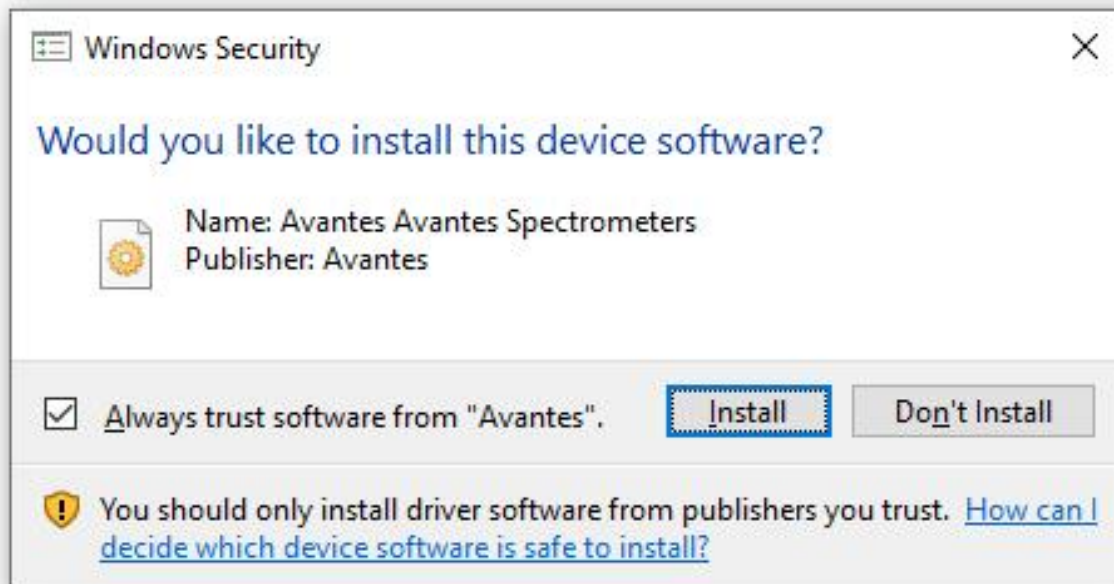
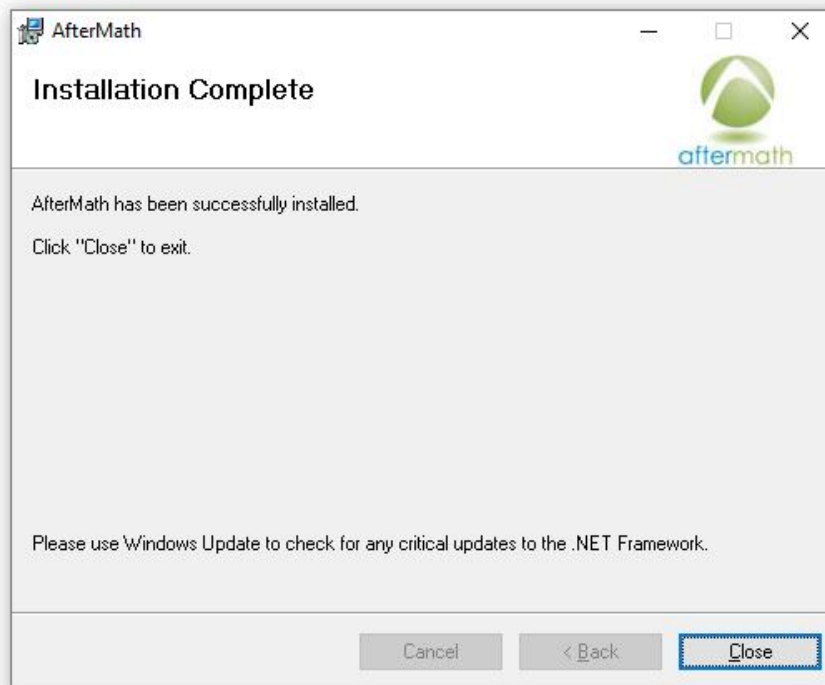

Figure 3-13. Windows Security Prompt to Install Device Software



**Figure 3-14. Confirmation of Successful AfterMath Installation**

### 3.2.2 Permissions File Verification

On the installation media, there are license files, or “permissions files”, which authorize a computer running AfterMath to control specific instruments (see Figure 3-15). If Aftermath is installed on the computer using the installation media shipped with a particular instrument, then these permissions files are automatically copied to the computer.

If AfterMath is downloaded directly from the internet and installed on a computer, then the permissions files may not be present on the computer. Users typically notice this condition when the AfterMath “Perform” button is disabled (gray shading – see Figure 3-16). To be sure the proper permissions files are on the computer, launch the AfterMath software. Separately, view the content on the installation media and locate the permissions files (ending in \*.papx file extension). Next, drag and drop the permissions files from the installation media directly into the upper left section of the AfterMath window (see Figure 3-17). The AfterMath program will remember the permissions files even after the program is closed (*i.e.*, this step only needs to be performed once). You may be prompted to accept changes by the AfterMath program.



**NOTE:**

**Contact Technical Service for assistance (see Section 1.6) if you encounter any issues with software licensing or permissions files.**



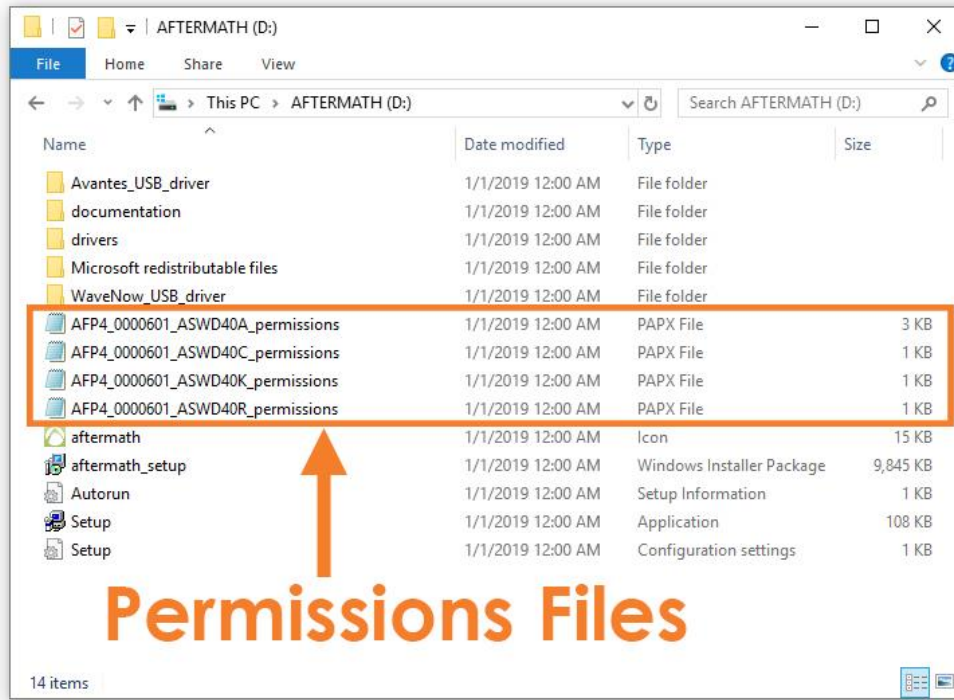

Figure 3-15. Permissions Files on Installation Media

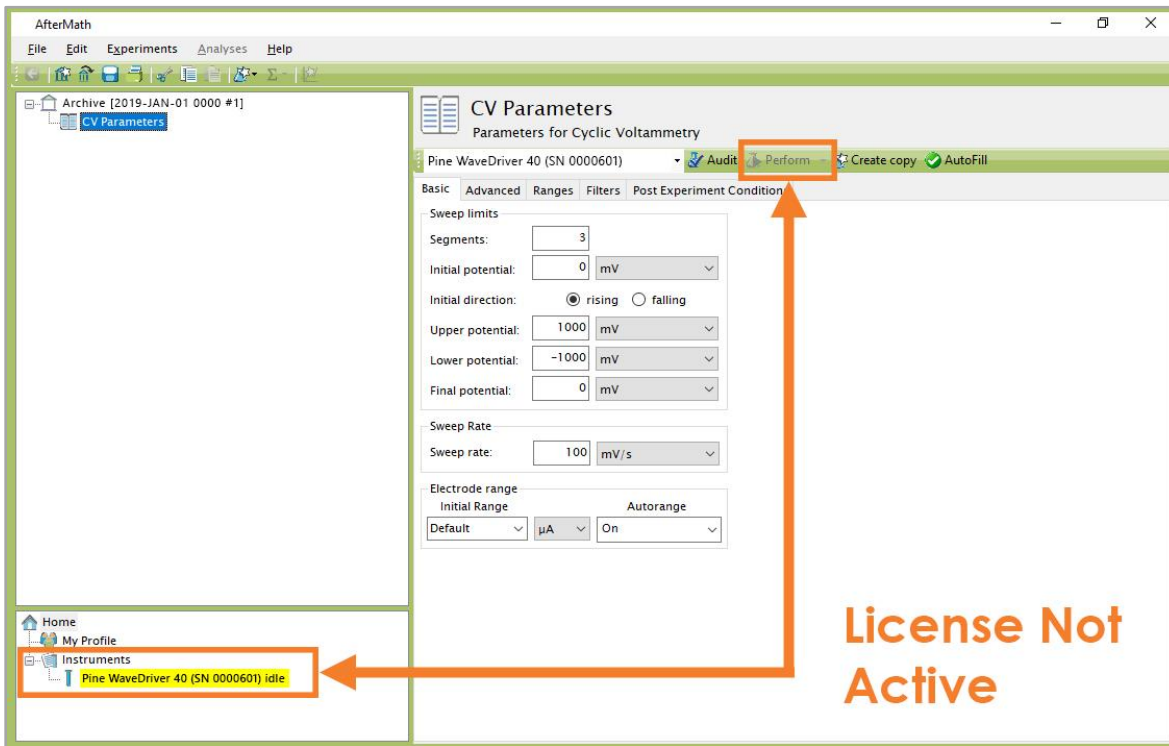

Figure 3-16. Indications that the AfterMath License is not Active



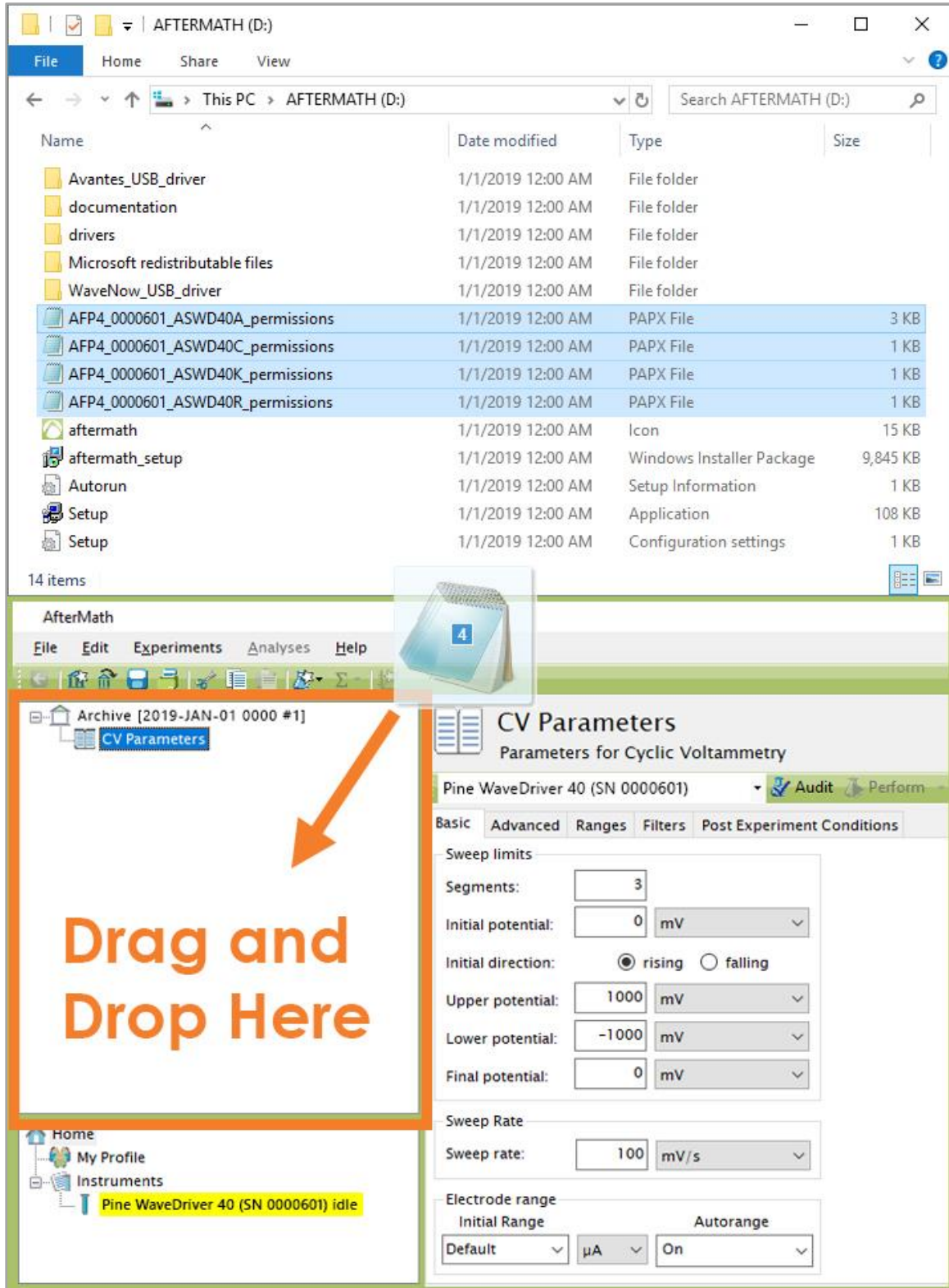

Figure 3-17. Copying Permissions Files to AfterMath

### 3.3 USB Cable Connection

The WaveDriver 40 connects to a computer using the USB cable supplied with the instrument (Type A male to Type B female USB cable – see Figure 3-18). The USB port on the computer must be capable of USB 2.0 (or better) data transfer rates.



Figure 3-18. USB Cable Connection Between Potentiostat and Computer

### 3.4 Installation Checklist

The next section of this guide will describe testing of a fully-installed WaveDriver 40. Before proceeding, ensure the following installation steps have been completed:

- ✓ The WaveDriver 40 instrument is located in a secure, dry location with adequate space
- ✓ Electrical power is connected to the WaveDriver 40
- ✓ AfterMath software is installed on the computer
- ✓ The WaveDriver 40 instrument is connected to a computer via the USB cable

## 4. System Testing

This section describes how to test the WaveDriver 40 system. By connecting the bipotentiostat to a well-behaved network of resistors and capacitors (using the Pine Research Universal Dummy Cell), the bipotentiostat circuitry can be tested to assure that it is working properly.



**TIP:**

To verify the instrument is operating correctly, perform the system tests described here. When contacting Technical Service (see Section 1.6) for assistance, the tests described below are often the first suggested actions.

### 4.1 Test Setup

#### 4.1.1 Launch the AfterMath Software

Launch AfterMath, which should already be installed on the computer (see Section 3), and log into AfterMath (see Figure 4-1). Click "OK" on the AfterMath Login dialog window to start the program.

**Click the  
AfterMath  
icon to  
launch the  
application**

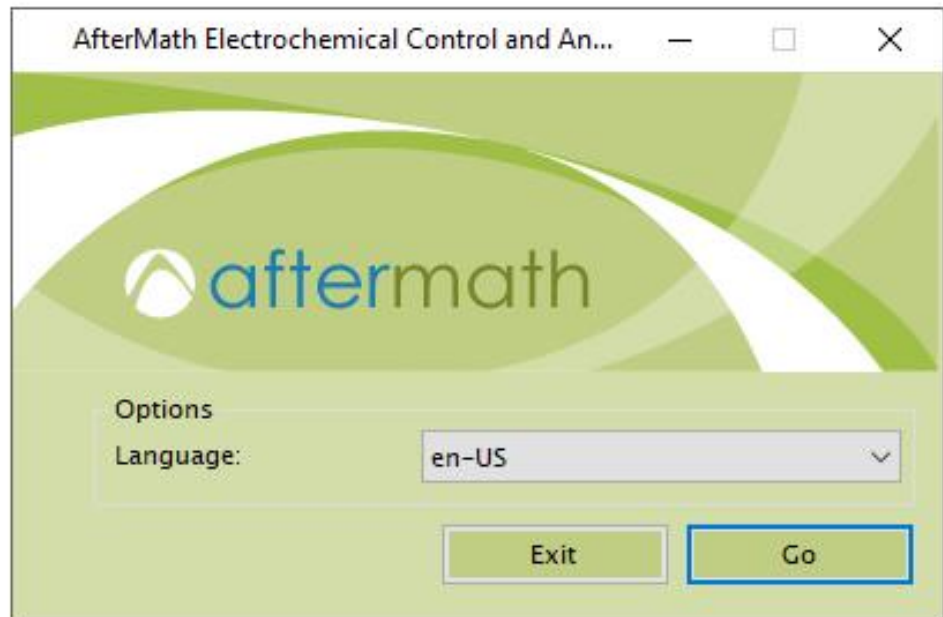

**Figure 4-1. Initial Login Screen when Starting AfterMath**

#### 4.1.2 Verify Instrument Status

Turn on the instrument using the front panel power switch and wait for the WaveDriver 40 to appear in the AfterMath instruments list. The instrument should appear along with its serial number under the "Instruments" node (see lower-left portion of the screenshot shown in Figure 4-2).

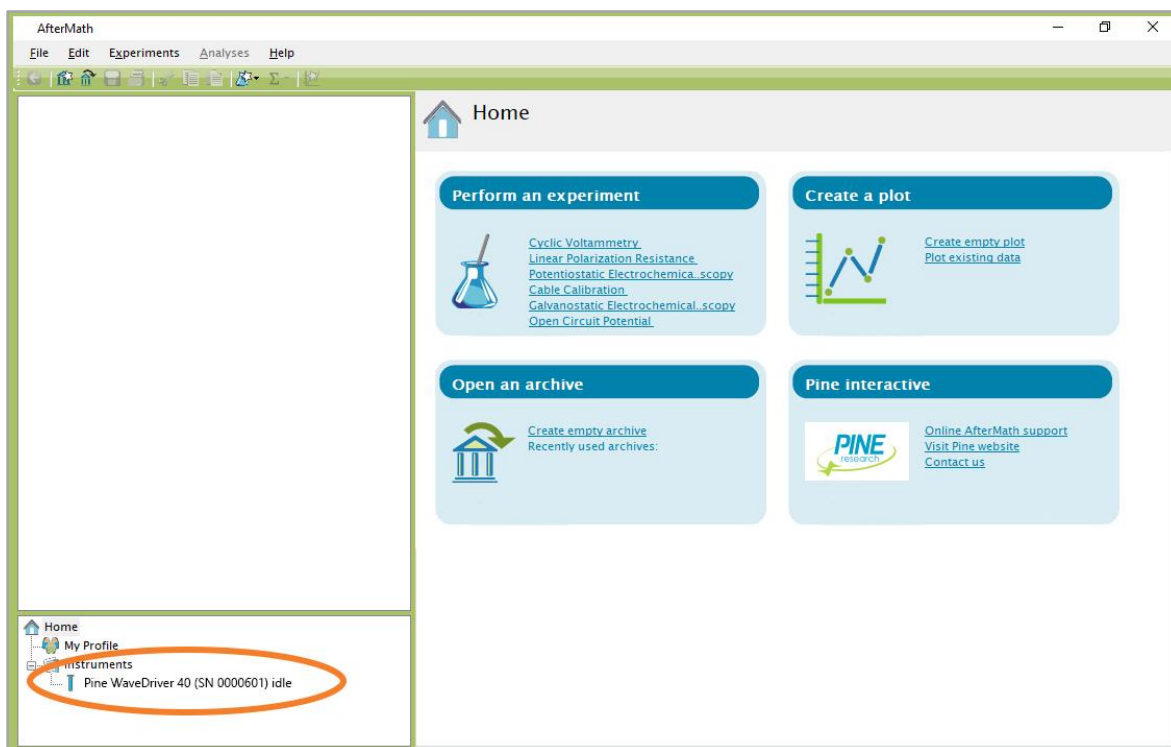

Figure 4-2. AfterMath Screenshot with Connected Instrument Circled

### 4.1.3 Confirm Connections

Check the status LED on the front panel of the WaveDriver 40. After about fifteen seconds, this LED should be green, indicating that the instrument is idle (see Figure 4-3). Also, the USB indicator light should flicker occasionally (see Table 2-4 for more information about LED indicators).



Figure 4-3. Indicator Lights on the Front Panel of the WaveDriver 40

## 4.1.4 Review Instrument Status

Examine the instrument status display (see Figure 4-4). The information on the “Idle” tab may initially indicate that the cell is disconnected. If desired, the controls on this tab can be used to apply a known idle condition to the cell. In the example shown below (see Figure 4-4), the instrument is connected to the external cell, and both working electrodes are set to idle under potentiostatic control while applying 1.2 V to the first working electrode (K1) and 0.0 V to the second working electrode (K2).

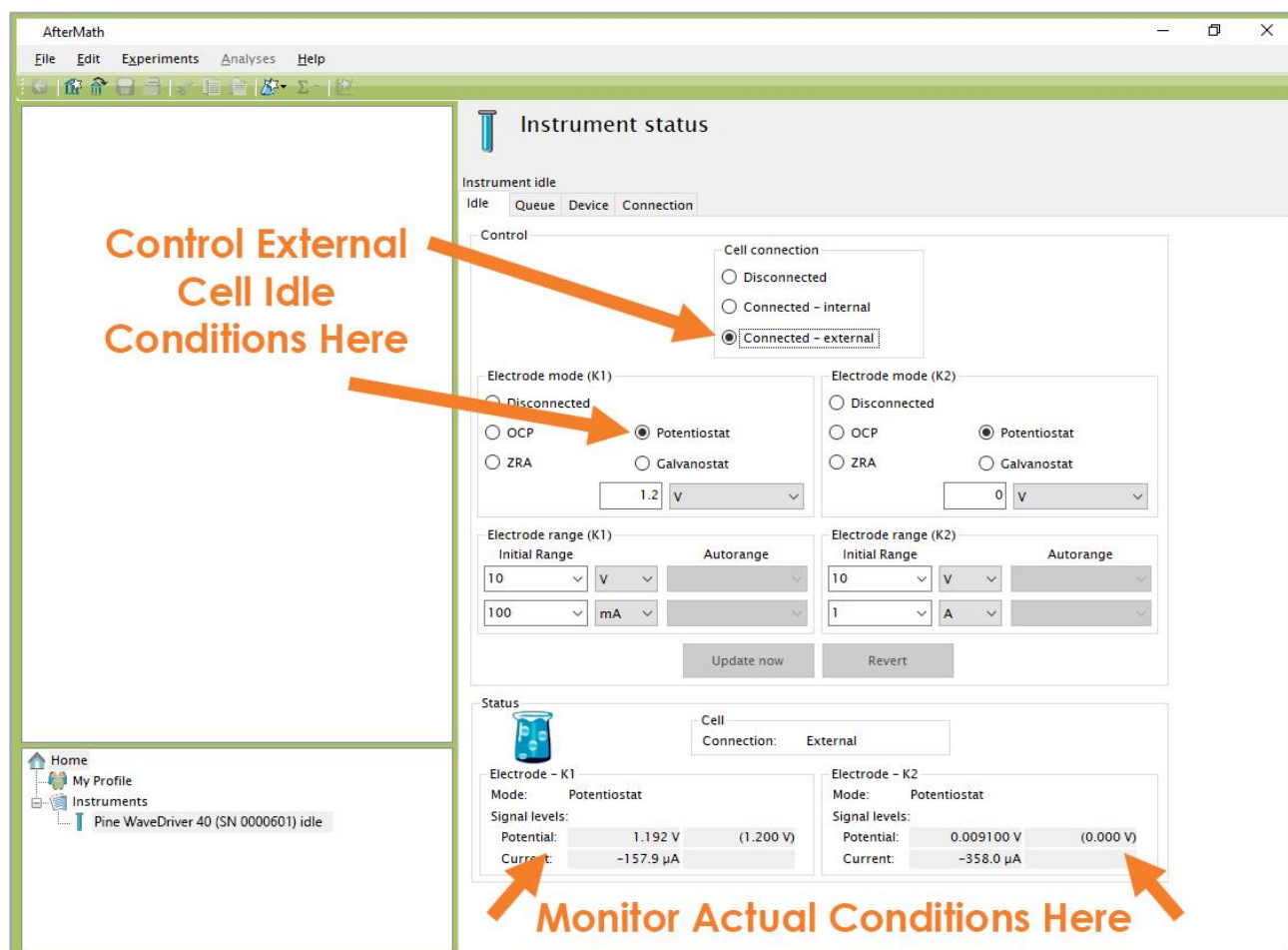

Figure 4-4. AfterMath Instrument Status Window showing External Cell Idle Conditions

## 4.2 Single Channel (K1) DC Test

### 4.2.1 Connect to the Pine Research Universal Dummy Cell



**NOTE:**

If using the legacy Universal Dummy Cell (Pine Research part number AFDUM3) that was included with a WaveDriver 40 purchased before November 2020, refer to corresponding instructions in Section 9.2.



Securely connect the cell cable to the front panel of the WaveDriver 40. Remove the alligator clip from the RED lead and plug it into the back of the ORANGE lead so the leads are stacked together. Do the same with the GREEN lead into the WHITE lead, and the BLUE lead into the PURPLE lead. Using an alligator clip, connect the RED+ORANGE stacked leads to the metal post labeled "WK1+WK1S" on "Cell C" of the Pine Research Universal Dummy Cell. Next, connect the GREEN+WHITE leads to the metal post labeled "CTR+REF", and connect the BLUE+PURPLE leads to the metal post labeled "WK2+WK2S" (see Figure 4-5, left). Place the connected dummy cell into the bottom half of the dummy cell metal case.

Connect the GRAY lead (instrument chassis) to the banana jack on the side of the metal case. Connecting the two chassis terminals together effectively shields the instrument circuitry and the components of the dummy cell within the same overall Faraday cage (see Section 6 to learn more about grounding). Slide the top half of the metal case into place (see Figure 4-5, right).

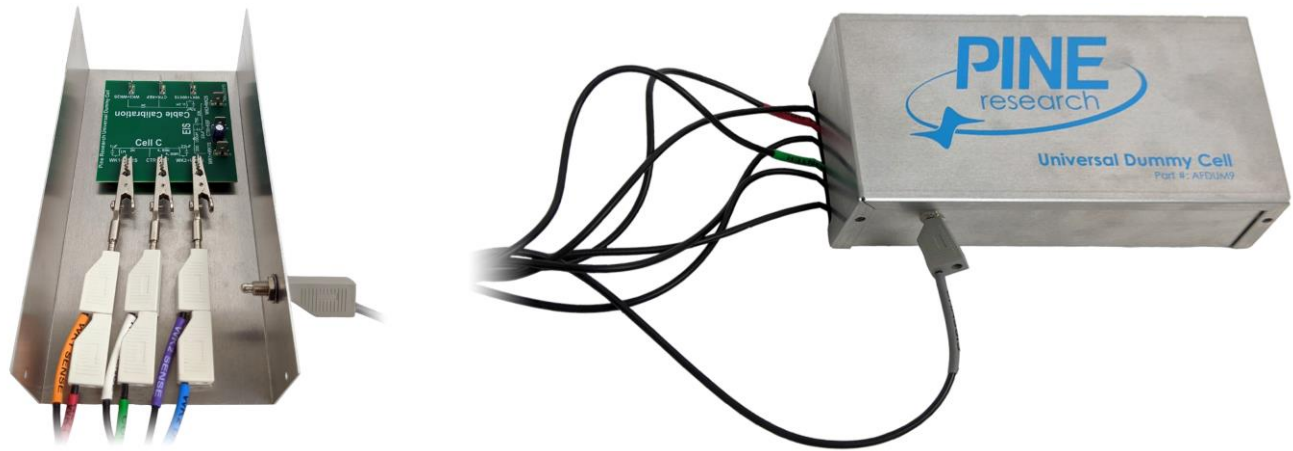

**Figure 4-5. WaveDriver 40 Cell Cable Connected to "Cell C" of Dummy Cell**

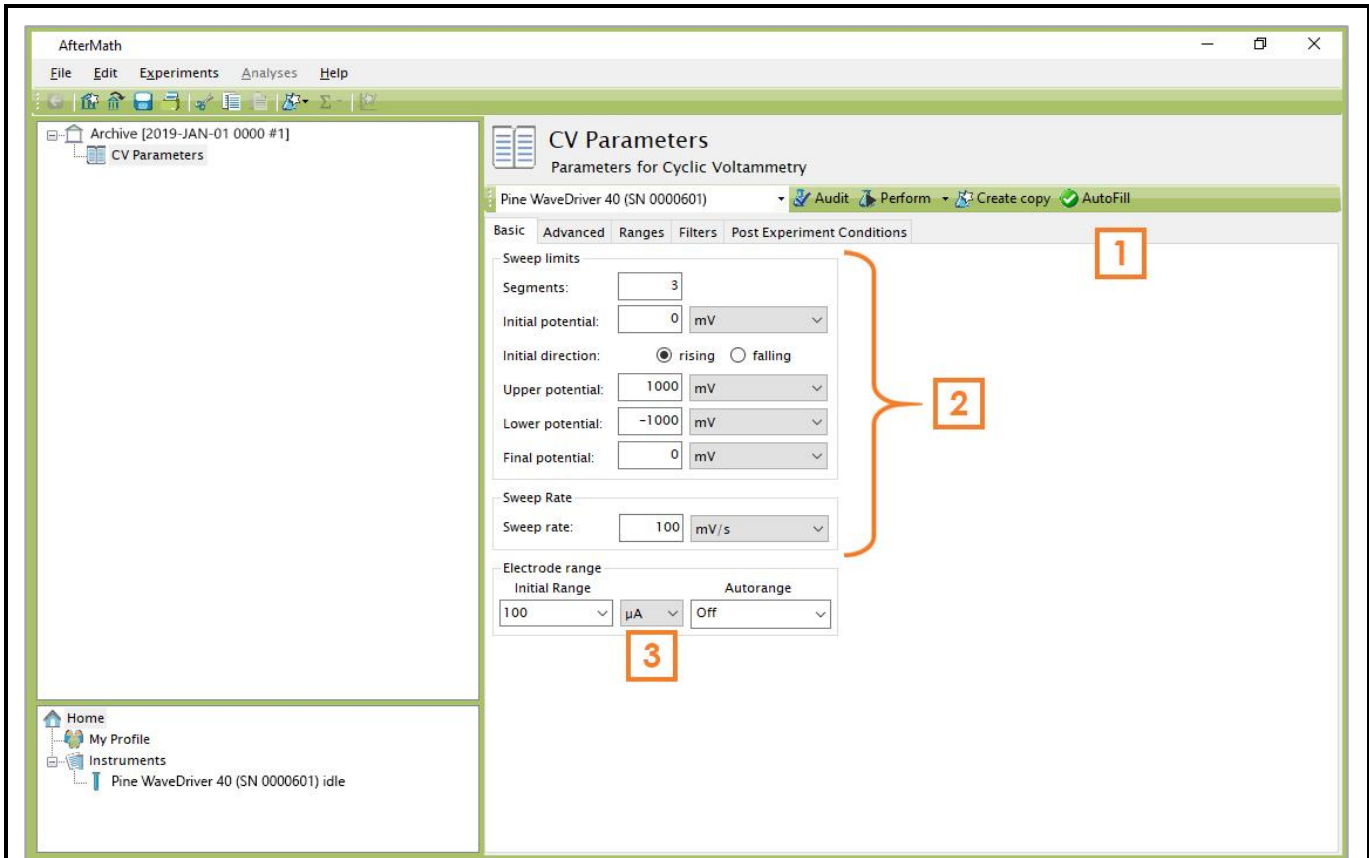

1	Click on the “AutoFill” button. Note that default parameters appear automatically (including the Number of Segments, the Sweep Limits, and the Sweep Rate).
2	These parameters control the waveform used during the experiment.
3	Set the Electrode Range to “100 $\mu$ A” and set Autorange “Off” (this disables auto-ranging and selects the 100 $\mu$ A range for use throughout the test).

**Figure 4-6. Cyclic Voltammetry (CV) Parameters Dialog Window**

#### 4.2.2 Create a Cyclic Voltammetry (CV) Experiment

From the AfterMath Experiments menu, choose Cyclic Voltammetry (CV). Doing so creates a “CV Parameters” node within a new archive. Configure the parameters as shown (see Figure 4-6).

#### 4.2.3 Audit Experimental Parameters

Choose the WaveDriver 40 bipotentiostat in the drop-down menu (see Figure 4-7, to the left of the “Audit” button), and then press the “Audit” button to check the parameters. AfterMath will perform a quick audit of the parameters to ensure that all parameters are specified and within allowed ranges.

#### 4.2.4 Initiate the Experiment

Click the “Perform” button to initiate the CV experiment. The “Perform” button is located just to the right of the “Audit” button (see Figure 4-7).

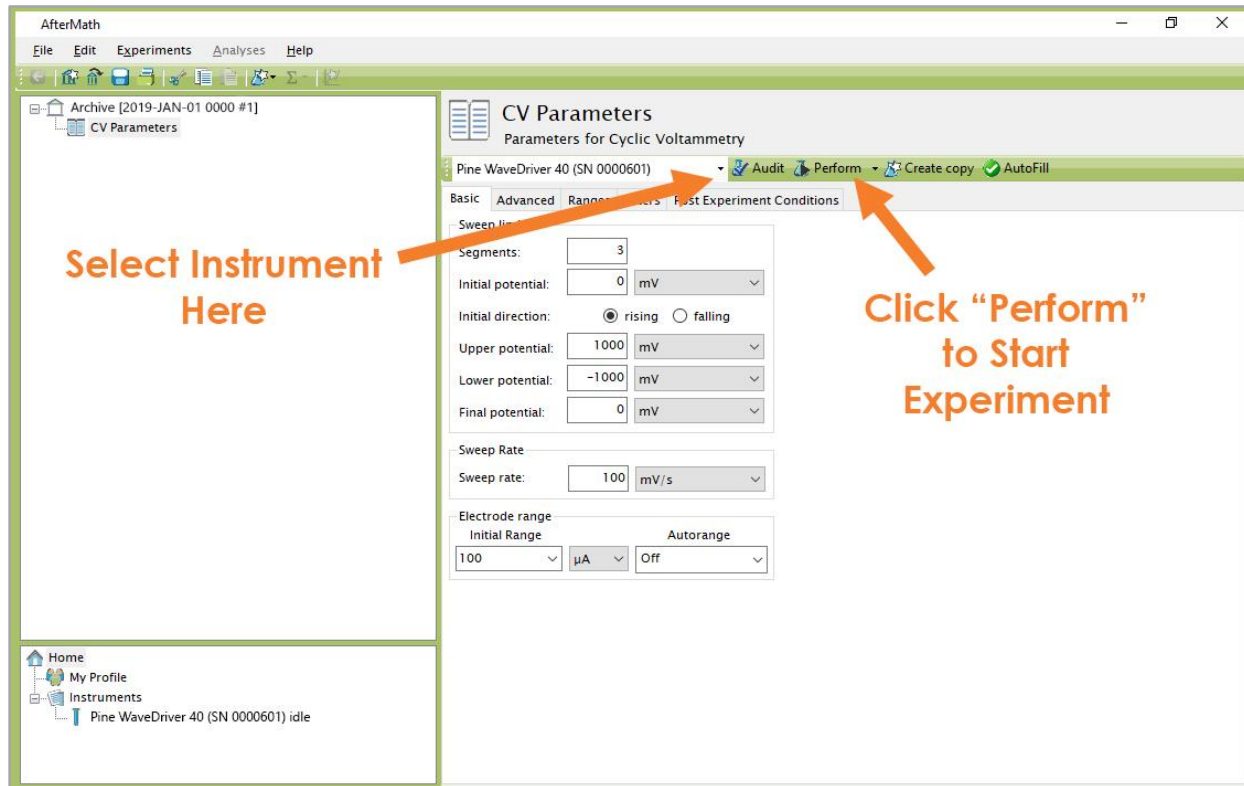

Figure 4-7. Location of Instrument Selection Menu and Perform Button



**NOTE:**

If the “Perform” button is disabled (shaded gray), this is an indication that the AfterMath software on the computer is not licensed to control the instrument. The remedy for this issue is to obtain and install the appropriate permissions files (see Section 3.2.2).

#### 4.2.5 Monitor Experimental Progress

Monitor the progress of the experiment by observing the real time plot, the percentage complete value, and the progress bar (see Figure 4-8).



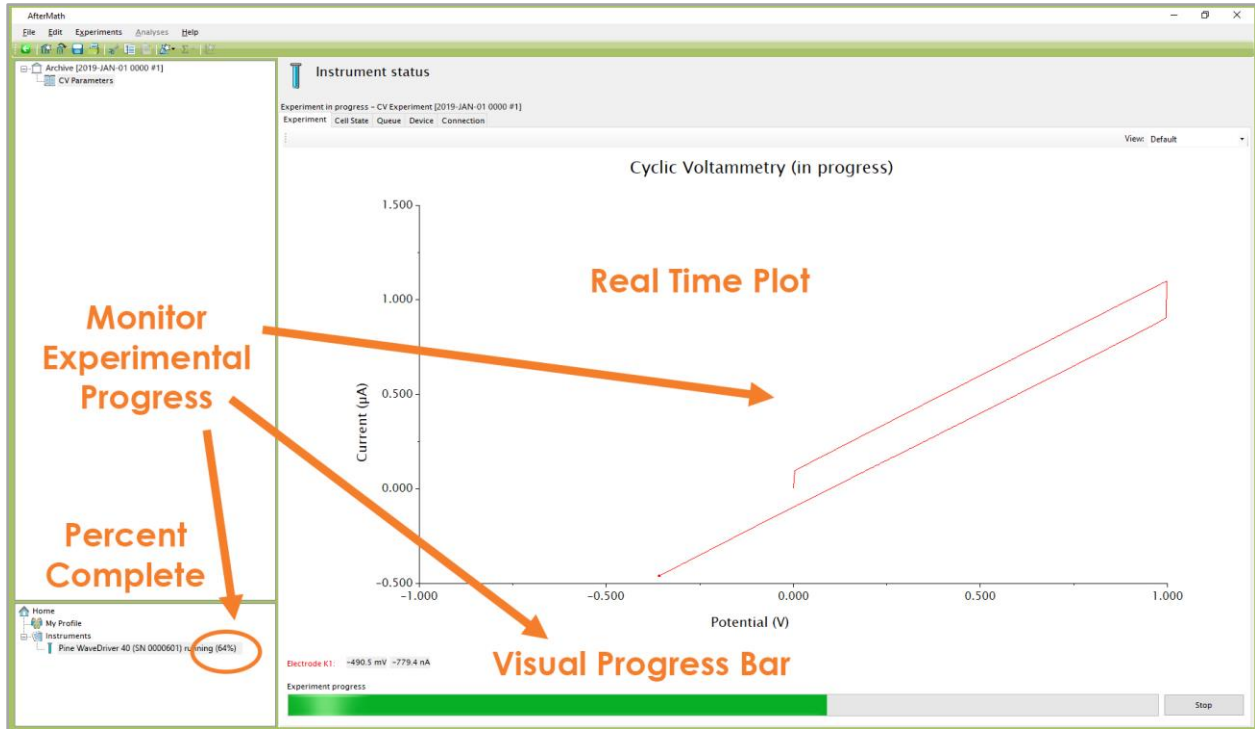



Figure 4-8. Monitoring the Progress of the CV Experiment

#### 4.2.6 Review the Results

When the experiment is complete, the results of the experiment are placed in a folder within the archive (see Figure 4-9). In addition to the main voltammogram plot, additional graphs are available in the “Other Plots” folder. The results can also be viewed in tabular form under the “experiment” node.



**EXPECTED RESULT:**

The anticipated test result (see Figure 4-9) is a diagonally-slanted parallelogram. The slope of this parallelogram (~998 nS) is the reciprocal of the dummy cell resistance (~1.002 MΩ). The vertical height at any given position along the parallelogram is related to the dummy cell capacitance (see Section 4.2.7 for more details).

#### 4.2.7 Understanding the Results

The total resistive load sensed by the first working electrode (K1) is a series combination of two resistors with values 1.0 MΩ and 2.0 kΩ (see Figure 9-1 for the schematic of the Pine Research Universal Dummy Cell). The voltammogram is a plot of current vs. potential governed by Ohm's Law as follows,

$$E = iR \quad (\text{Ohm's Law}) \quad (1)$$

where  $E$  is the potential,  $i$  is the current, and  $R$  is the resistive load. Considering that the cyclic

voltammogram (see Figure 4-9) plots current along the vertical axis and potential along the horizontal axis, the slope ( $i/E$ ) is equal to the reciprocal of the resistive load ( $1/R = 1 / 1.002 \text{ M}\Omega = 998 \text{ nS}$ ).

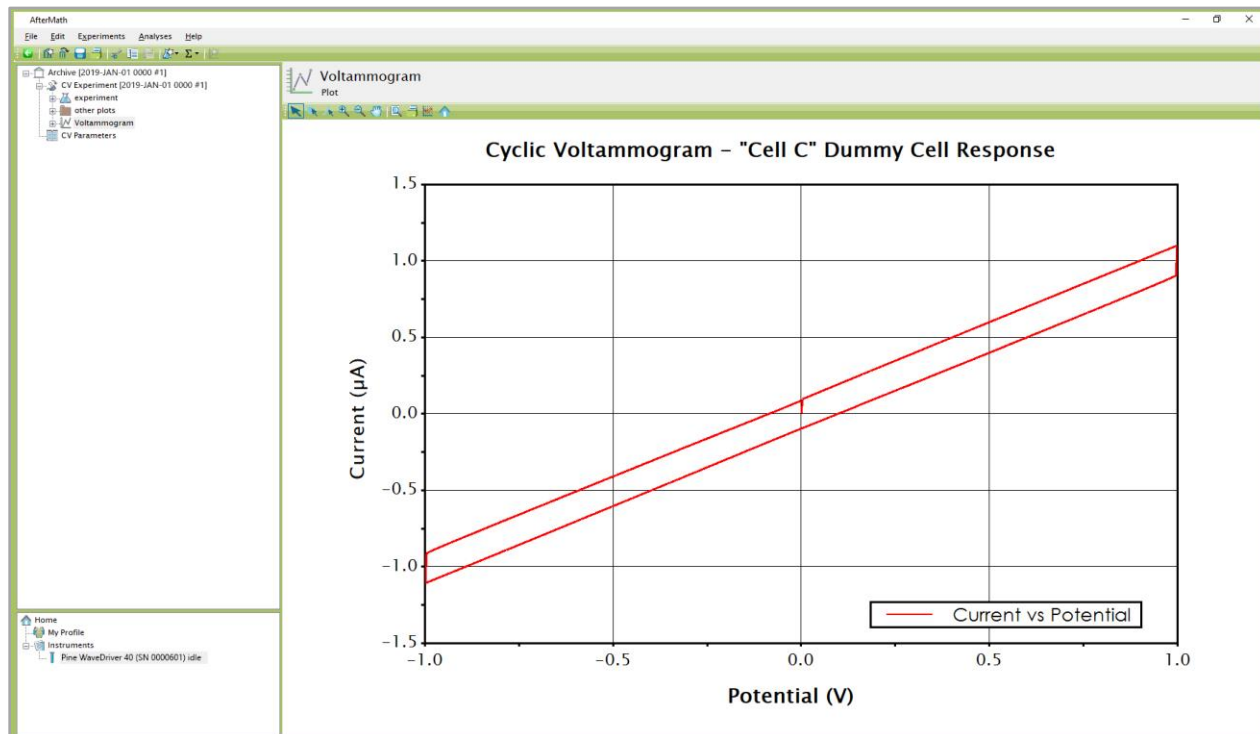

**Figure 4-9. Anticipated CV Results (using “Cell C” of Dummy Cell)**

To measure the actual slope, right-click on the cyclic voltammogram trace, and then select the “Baseline” option from the “Add Tool” sub-menu. A baseline measurement tool appears on the voltammogram (see Figure 4-10), and by adjusting the tool control points, the slope along any portion of the voltammogram can be measured. The slope along the diagonal part of the voltammogram should be  $\sim 998 \text{ nS}$ .

The capacitive load presented to the working electrode is  $\sim 1.0 \mu\text{F}$  (see Figure 9-1 for the schematic of the Pine Research Universal Dummy Cell). The vertical separation observed between the forward and reverse segments at any point along the voltammogram is related to this capacitance. This capacitance is meant to mimic the double-layer capacitance,  $C_{DL}$ , observed at the surface of an actual electrode.

Whenever a potential sweep is applied across a capacitive load, a charging current is observed. In the context of the electrode double-layer concept, the double-layer charging current ( $i_{DL}$ ) is related to the potential sweep rate ( $v$ ) and the double-layer capacitance ( $C_{DL}$ ) by the following equation:

$$i_{DL} = C_{DL}v \quad (2)$$

A cyclic voltammogram across a capacitor consists of a forward (*i.e.*, charging) segment and a reverse (*i.e.*, discharging) segment. The vertical separation between the two segments at any point along the voltammogram is two times the capacitive charging current.

To measure this vertical separation in AfterMath, right-click on the voltammogram trace and select the “Crosshair” option from the “Add Tool” sub-menu. Drag the crosshair cursor to any point on the upper segment of the voltammogram and make note of the current and potential at that point (see Figure 4-10). Next, create a second crosshair tool and drag it to the lower segment of the voltammogram. Position the second crosshair at the same (or nearly the same) potential as the first crosshair tool and make a note of the current and potential at that point.

Half the difference between the currents measured at the two crosshair points is the charging current. For the example shown here (see Figure 4-10), half the difference in current between the two points is calculated as  $0.0988 \mu\text{A}$ . With knowledge of the potential sweep rate ( $100 \text{ mV/s}$ ), the capacitive load can be calculated as  $0.988 \mu\text{F}$ , which is in good agreement with the nominal capacitance shown in the dummy cell circuit schematic (see Figure 9-1).

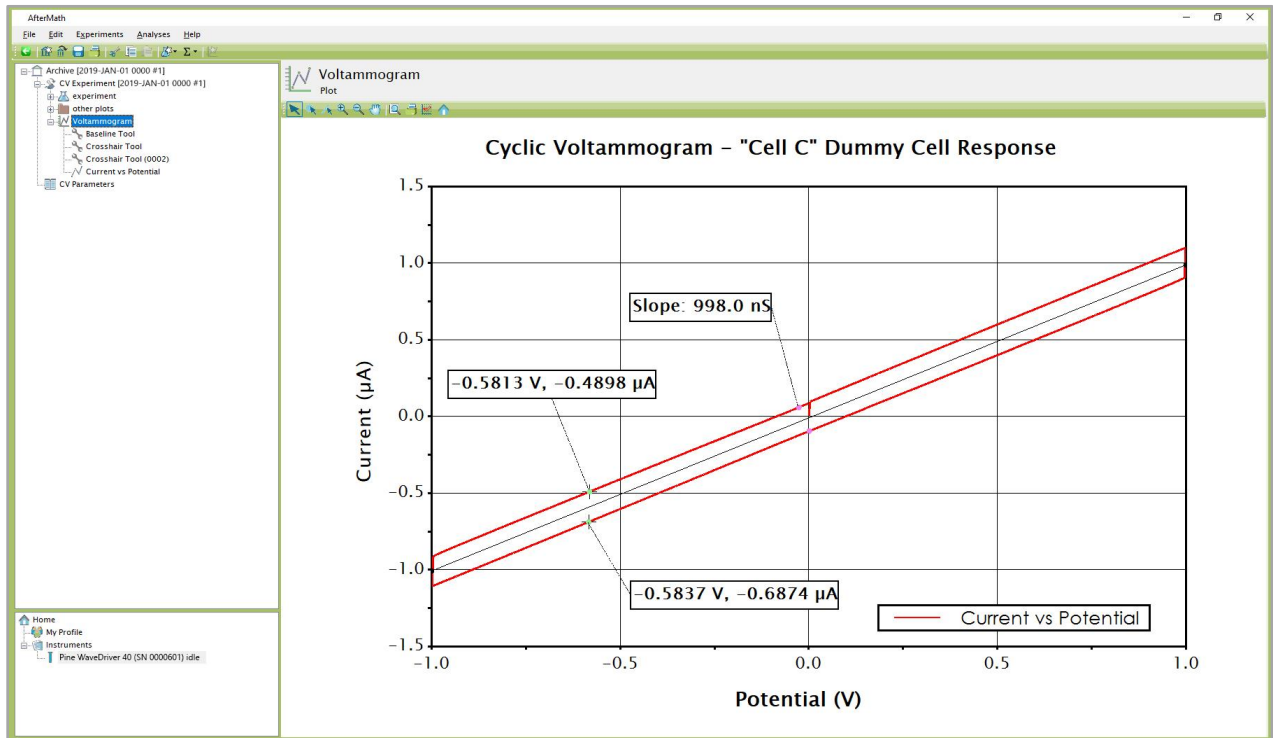

Figure 4-10. Analyzed CV Results (using “Cell C” of Dummy Cell)

#### EXPLORE ADDITIONAL EXPERIMENTAL RESULTS:



Archive nodes often have a “+” sign next to the node name. Click on this “+” sign to open the node. In addition to the main plot produced by an experiment, additional results can be found in the “Experiment” node and in the “Other Plots” node. Nodes may be renamed and organized in folders as desired.

## 4.3 Dual Channel (K1 and K2) DC Test

### 4.3.1 Connect to the Pine Research Universal Dummy Cell



#### NOTE:

If using the legacy Universal Dummy Cell (Pine Research part number AFDUM3) that was included with a WaveDriver 40 purchased before November 2020, refer to corresponding instructions in Section 9.2.

Connect the WaveDriver 40 cell cable leads to “Cell C” of the Pine Research Universal Dummy Cell in identical fashion to the previous Single Channel DC Test (see Section 4.2.1 for connection instructions; see Figure 4-5 for illustration).

### 4.3.2 Create a Dual Electrode Cyclic Voltammetry (DECV) Experiment

Choose the Dual Electrode Cyclic Voltammetry (DECV) option from the Dual electrode methods sub-menu in the AfterMath Experiments menu. A new DECV specification will be created and placed into a new archive. Configure the parameters as detailed below (see Figure 4-11).

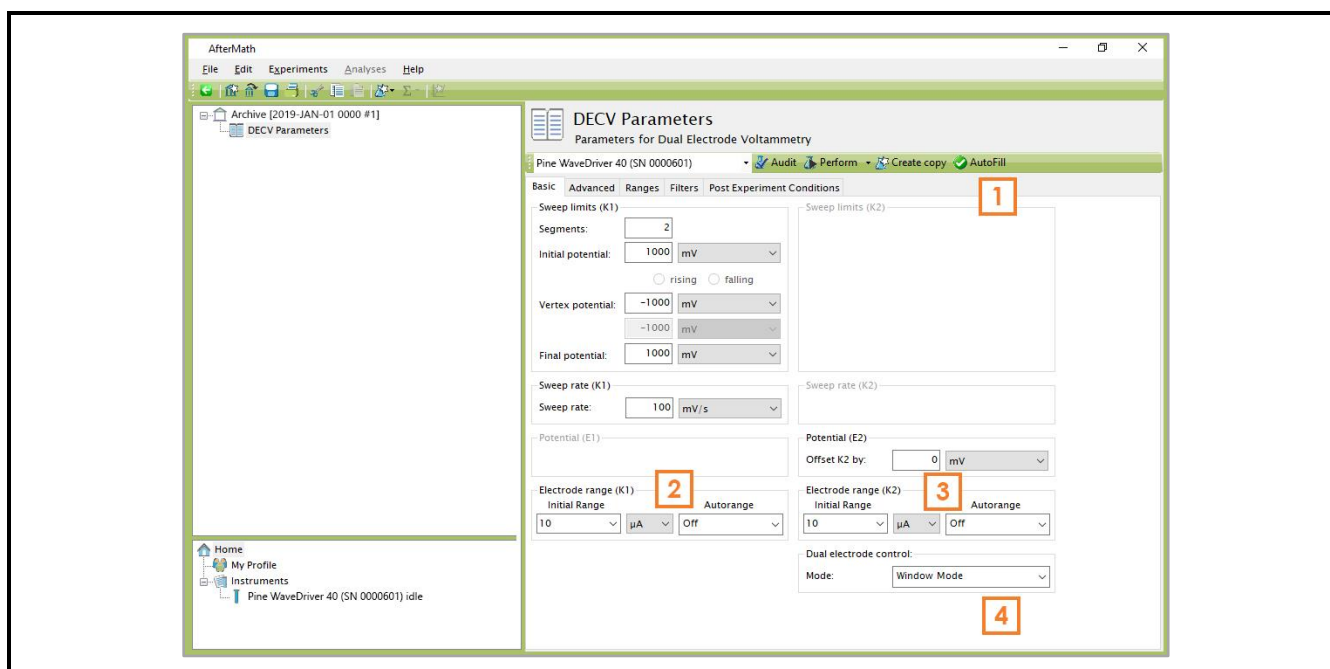

1	Click on the “AutoFill” button. Note that default parameters for number of Segments, Sweep limits, and Sweep rate appear automatically.
2	Set the Electrode range (K1) to “10 $\mu$ A” with Autorange “Off”
3	Set the Electrode range (K2) to “10 $\mu$ A” with Autorange “Off”
4	Change the Dual electrode control mode to “Window Mode”

Figure 4-11. Dual Electrode Cyclic Voltammetry (DECV) Parameters Dialog Window

### 4.3.3 Modify the Potential Range Setting

Select the 2.5 V range for both working electrodes (K1 and K2) via the following steps:

1. Click the “Ranges” tab (see Figure 4-12).
2. Change the potential electrode range for both K1 and K2 to 2.5 V and set Autorange to “Off”.

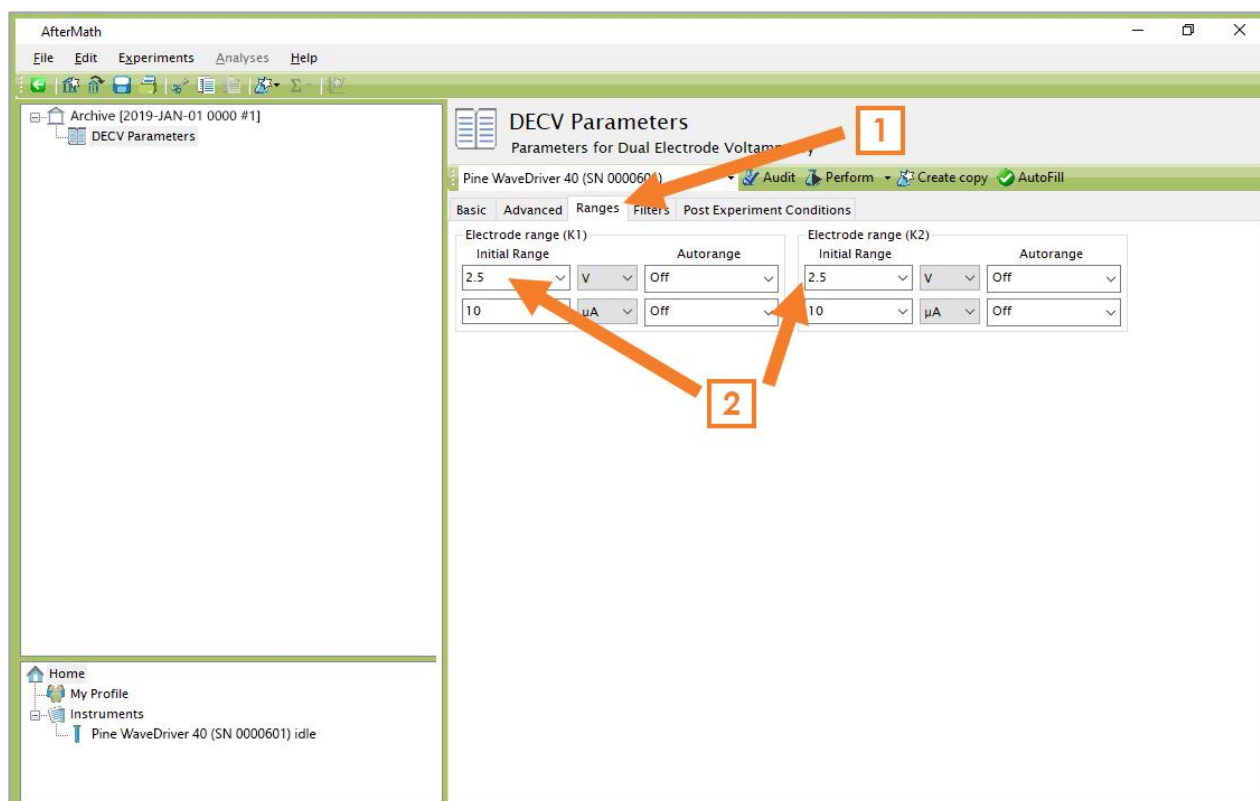

Figure 4-12. Adjusting the Potential Ranges on the “Ranges” Tab (DECV)

### 4.3.4 Audit Experimental Parameters

Choose the WaveDriver 40 in the drop-down menu (see Figure 4-13, to the left of the “Audit” button). Press the “Audit” button to check the parameters. AfterMath will perform a quick audit of the parameter values to ensure that all required parameters have been specified and are within allowed ranges.

### 4.3.5 Initiate the Experiment

Click on the “Perform” button to initiate the DECV experiment. The “Perform” button is located to the right of the “Audit” button (see Figure 4-13).

### 4.3.6 Monitor Experimental Progress

Monitor the progress of the DECV experiment in AfterMath by observing the real time plot, the percentage complete value, and the progress bar (see Figure 4-14).

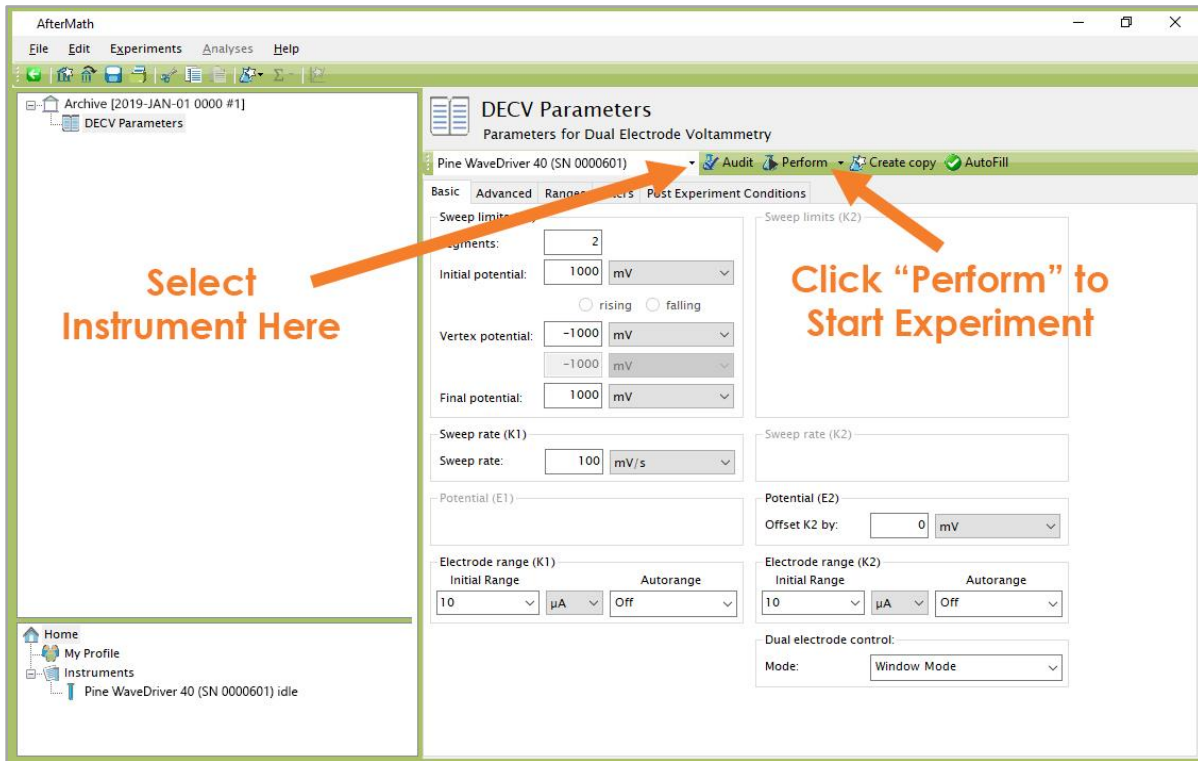

Figure 4-13. Location of Instrument Selection Menu and Perform Button (DECV)

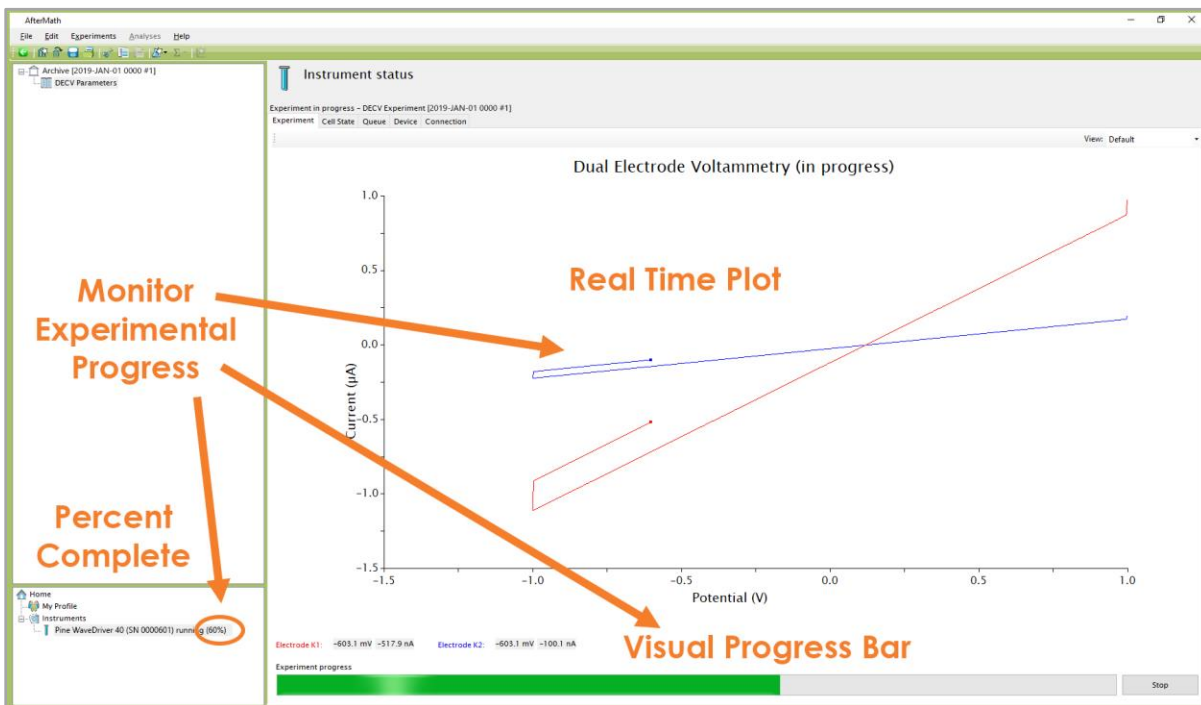

Figure 4-14. Monitoring the Progress of the DECV Experiment (K1 and K2)



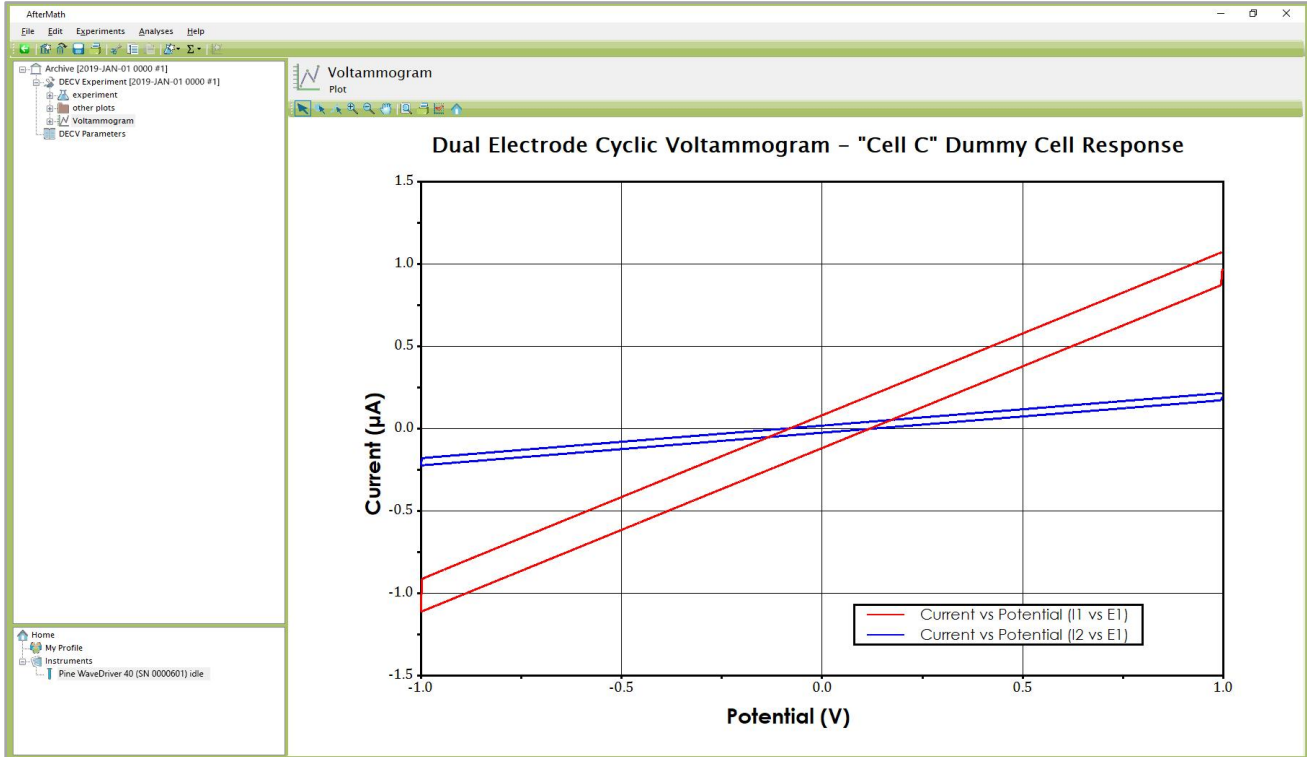

Figure 4-15. Anticipated DECV Results (using “Cell C” of Dummy Cell)

#### 4.3.7 Review the Results

When the experiment has finished, the results of the experiment are placed in a folder within the archive (see Figure 4-15). In addition to the voltammogram, additional graphs are available in the “Other Plots” folder. The results can also be viewed in tabular form under the “Experiment” node.

##### EXPECTED RESULT:



The anticipated test results are two diagonally-slanted parallelograms with different slopes (see Figure 4-15). The slope of the red trace is inversely proportional to the resistance sensed by first working electrode ( $\sim 1.002 \text{ M}\Omega$ ), and the slope of the blue trace is inversely proportional to the resistance sensed by the second working electrode ( $\sim 5.005 \text{ M}\Omega$ ). The vertical separation between sweep segments is related to the capacitance sensed by the both working electrodes (see Section 4.3.8).

#### 4.3.8 Understanding the Results

Analysis of the DECV results is similar to the single channel CV test (see Section 4.2.7), except there are two voltammograms instead of one (see Figure 4-15). The red voltammogram corresponds to the first working electrode (K1) and the blue voltammogram corresponds to the second working electrode (K2). The overall resistive loads presented to the working electrodes by the dummy cell (see Figure 9-1) are  $1 \text{ M}\Omega + 2 \text{ k}\Omega = 1.002 \text{ M}\Omega$  (for K1) and  $4.99 \text{ M}\Omega + 5 \text{ k}\Omega = 4.995 \text{ M}\Omega$  (for K2).

AfterMath software baseline tools may be used to measure the slopes of the two voltammograms (see Section 4.2.7 for baseline tool instructions), and Ohm's law (Equation 1) may be used to relate the measured slopes to the resistive load sensed by each electrode. For the example shown here (see Figure 4-16), the slope for the first voltammogram (K1) is calculated as 994.2 nS, and the slope for the second voltammogram (K2) is calculated as 198.2 nS. The reciprocals of these two slopes (1.006 M $\Omega$  for K1 and 5.045 M $\Omega$  for K2) are in good agreement with the resistive loads found on the dummy cell schematic (see Figure 9-1).

The nominal capacitive loads presented to the working electrodes by the dummy cell (see Figure 9-1) are 1  $\mu$ F (for K1) and 220 nF (for K2). Using the AfterMath software crosshair tools (in a manner similar to that described in Section 4.2.7) with the example voltammograms shown here (see Figure 4-16), the measured values (1.009  $\mu$ F and 223.6 nF) are in good agreement with the nominal capacitance values.

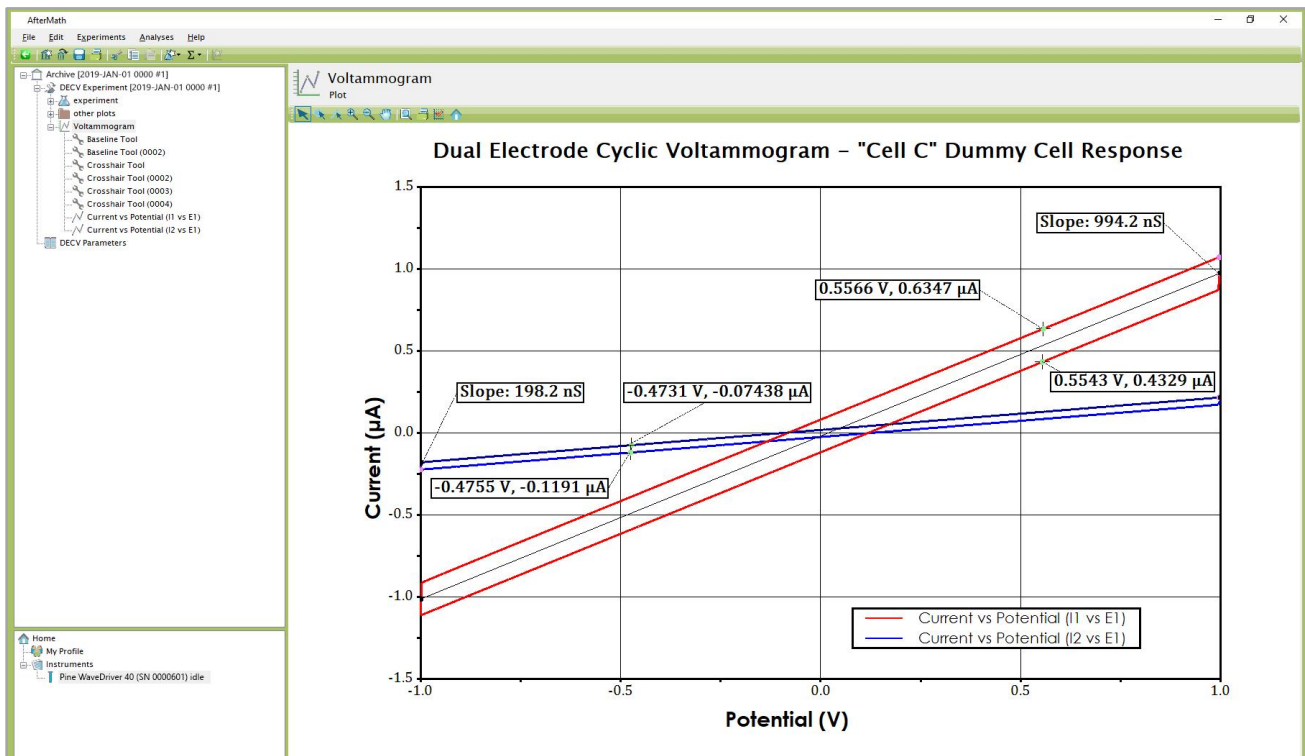

Figure 4-16. Analyzed DECV Results (using "Cell C" of Dummy Cell)



## 5. Cell Cable Connections

This section describes how to connect several different kinds of electrochemical cells to the WaveDriver 40. Before proceeding, the user should be familiar with general concepts associated with electrochemical cells and experimentation. Using the WaveDriver 40 Cell Cable (part number ACP3E01), connections can be made to simple two-terminal cells (such as batteries, fuel cells, solar cells, amperometry sensors, capacitors, resistors, and inductors), traditional three-electrode voltammetry cells (including those that contain a rotating disk electrode or a rotating cylinder electrode), compact voltammetry cells, and to more complex dual working electrode cells (including rotating ring-disk electrode cells).

### 5.1 Cell Cable Color Code

The front panel of the WaveDriver 40 has a large cell connection port containing several signal lines that may be connected to the various working, counter, and reference electrodes that may be present in an electrochemical cell. It is important to understand that some of the signal lines are low impedance DRIVE lines while others are high impedance SENSE lines. In general, the DRIVE lines are used to drive current through the electrochemical cell while the SENSE lines are used to carefully measure the potential at various electrodes.



**NOTE:**

**DRIVE lines are low impedance lines used to drive current.**

**SENSE lines are high impedance lines used to measure potential.**

The WaveDriver 40 Cell Cable breaks out the cell port connections to six shielded coaxial lines and one unshielded line (the GRAY instrument chassis line). The shielded coaxial lines terminate in banana plugs that are designed to be stacked as needed and directly connected to electrodes. Alligator clips that slide onto the banana plugs are included. A tabular summary of the color code for these lines is provided (see Table 5-1).

Color	Description	ID	Type
WHITE	Reference Electrode	REF	Sense
GREEN	Counter Electrode	CTR	Drive
GRAY	Instrument Chassis		Ground
RED	Primary Working Electrode (K1)	WK1	Drive
ORANGE	Primary Working Electrode (K1)		Sense
BLUE	Secondary Working Electrode (K2)	WK2	Drive
VIOLET	Secondary Working Electrode (K2)		Sense

**Table 5-1. WaveDriver 40 Cell Cable Color Description**

The instrument chassis lead is often connected to a Faraday cage surrounding the electrochemical cell. Less commonly used ground connections are also available (see Figure 5-1).

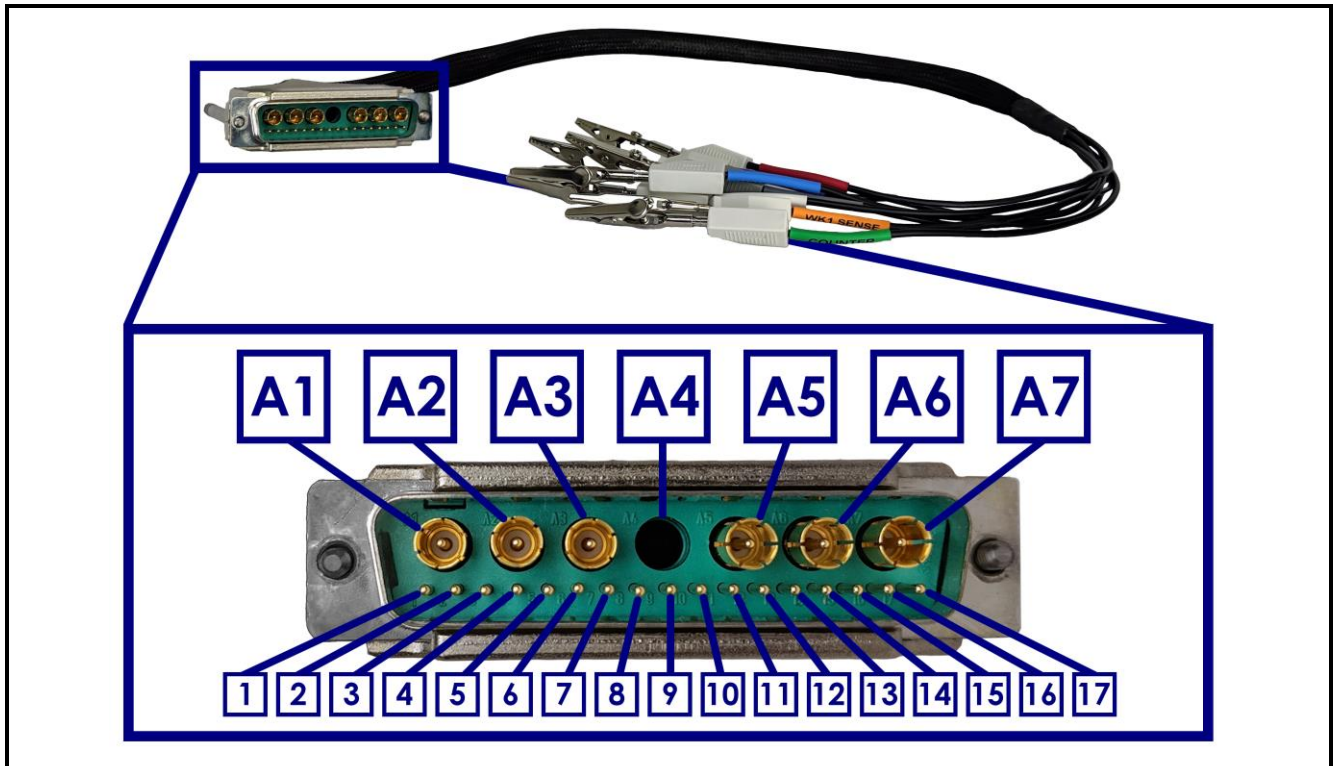

Pin	Signal	Pin	Signal
A1	Counter (CTR)	6	DC Common
A2	Working Sense 2 (K2) – includes terminating resistor	7	Cable Identification
A3	Working Drive 2 (K2)	8	
A4	Unused	9	
A5	Reference Sense (REF) – includes terminating resistor	10	
A6	Working Drive 1 (K1)	11	Unused
A7	Working Sense 1 (K1) – includes terminating resistor	12	
1	Analog Ground	13	
2	Unused	14	
3	Chassis Connection	15	
4		16	
5	Unused	17	

Figure 5-1. WaveDriver 40 Cell Port and Cell Cable Pinout



**NOTE:**

The high input impedance SENSE lines carry only very small currents during normal operation. Each of these SENSE lines is terminated with a resistor embedded within the banana plug at the end of the cable.

## 5.2 Experimental Configurations

With the proper cell cable configuration, several kinds of electrochemical systems can be connected to the WaveDriver 40. The following discussion of cell cable configurations assumes prior familiarity with the concepts associated with each type of electrochemical cell.

The WaveDriver 40 Cell Cable has a D-Shell connector that fits the cell cable port located on the front panel of the instrument. There are two thumbscrews on the D-Shell connector that tighten into the cell cable port to provide a secure connection (see Figure 5-2).



**Figure 5-2. Secure Connection of the WaveDriver 40 Cell Cable to the Cell Port**

As the cell cable emerges from the D-Shell connector, a conductive mesh shield runs along most of the length of the cable. This mesh shield is electrically connected to the chassis of the instrument and provides additional protection from environmental noise and ESD events.

At the cell end of the cable, multiple signal lines emerge from the mesh sleeve and terminate in banana plugs. All of these signal lines (except for the GRAY chassis line) are coaxial. The outer (shield) portion of each coaxial line further protects sensitive signals from environmental noise. Alligator clips (included) may optionally be installed on the banana plugs as needed.

When the WaveDriver 40 is not being used as a bipotentiostat (i.e., when there is not a second working electrode present in the cell), the banana plugs for the BLUE and VIOLET leads should be stacked together and set aside (see Figure 5-3). To prevent these leads from coming into contact with any conductive surface, they can optionally be placed inside a plastic bag.



**Figure 5-3. Unused K2 Electrode Lines**



**TIP:**

**Whenever the K2 electrode connections (BLUE and VIOLET) are not in use, short these banana plugs together and set them aside (see Figure 5-3).**

### 5.2.1 Two-Electrode Setups

Typical examples of two-electrode setups are solid-state experiments that probe electrochemical behavior across a single interface, experiments that involve ion-selective electrodes (where the open circuit potential is measured between an ion-selective electrode and a reference electrode), and rechargeable batteries consisting of an anode and cathode. Simple experiments with common electronic components (resistors, capacitors, and inductors) also use a two-electrode arrangement (see Figure 5-4).

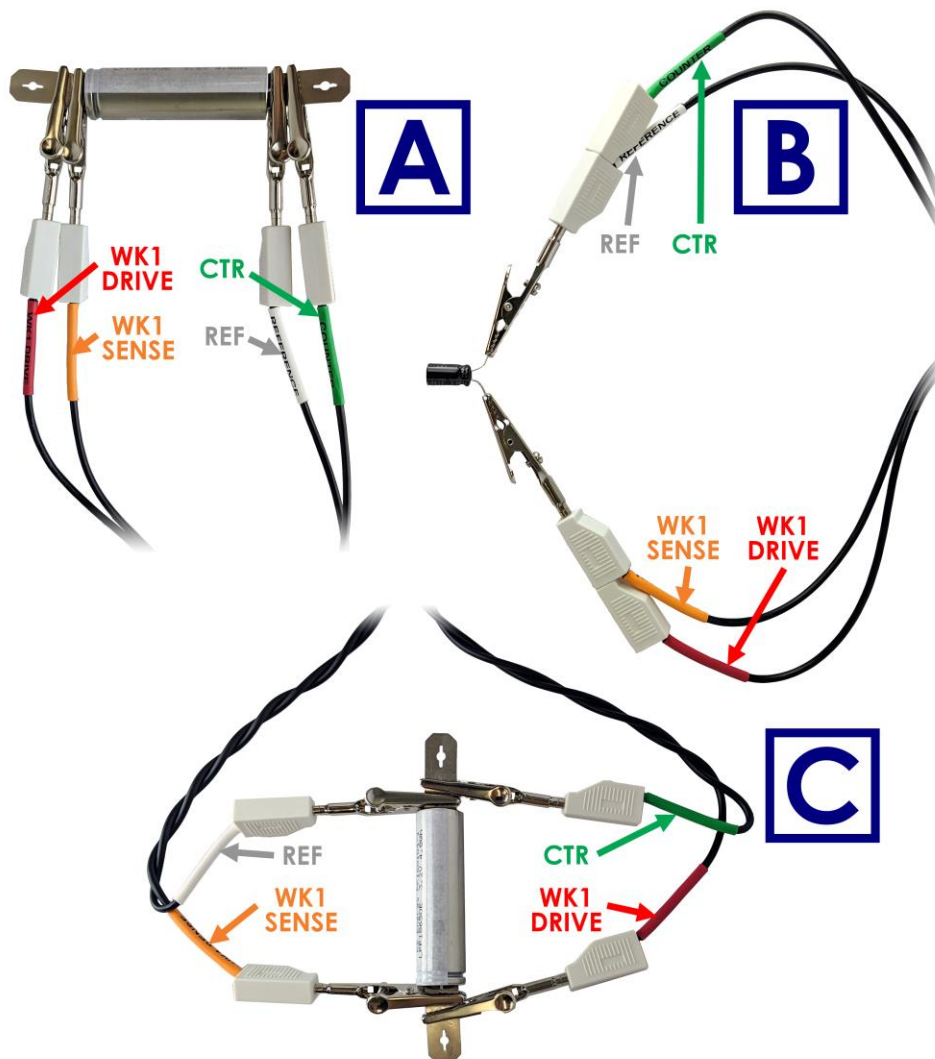

**Figure 5-4. Examples of Two-Electrode Setups**

The WaveDriver 40 Cell Cable can be configured for two-electrode experiments in a few different ways depending on the system under study. For many electrochemical setups, it is acceptable to simply stack together two pairs of banana plugs. The banana plugs for the GREEN (counter electrode) and WHITE (reference electrode) leads are stacked together to form the first pair, and the banana plugs for the RED and ORANGE leads (K1 electrode drive and sense) are stacked together to form the second pair (see Figure 5-4, B). One pair of shorted leads is connected to one of the electrodes in the system,

and the other pair is connected to the opposite electrode. Alternatively, each pair of leads can also be individually clipped to either electrode without stacking the banana plugs if desired (see Figure 5-4, A).

At low impedances ( $\sim 10\ \Omega$ ), cable inductance effects can be minimized by separately twisting the sense lines (ORANGE K1 sense and WHITE reference) and drive lines (RED K1 drive and GREEN counter) together (see Figure 5-4, C). The distance between the two sense lines (ORANGE and WHITE) should also be minimized as much as possible, and all connections should be closely spaced and secure to avoid added resistance from long electrode wires or leads. Conversely, at high impedances (above  $\sim 10\ \text{k}\Omega$ ), cable capacitance effects can be minimized by separating the RED and ORANGE lines from the GREEN and WHITE lines as much as possible (see Figure 5-4, B).

Using the recommended two-electrode polarity convention, the GREEN/WHITE pair should be connected to whichever electrode is considered to be the reference electrode. This convention assures that when the software applies a positive potential to the working electrode, the RED/ORANGE pair is more positive than the GREEN/WHITE "reference" pair. For example, when connecting to a battery or fuel cell, the positive electrode (cathode) should be considered the working electrode and connected to the RED/ORANGE pair while the negative electrode (anode) should be connected to the GREEN/WHITE pair. This will ensure the proper current and voltage conventions are observed when performing charge/discharge or polarization curve experiments.

When working with a simple two-electrode cell, the second working electrode (K2) drive and sense lines (BLUE and VIOLET lines) are not used. These leads should be shorted together and set aside (see Figure 5-3). These lines are meant for use only with dual working electrode experiments such as those involving a rotating ring-disk electrode (see Section 5.2.4).

### 5.2.2 Three-Electrode Cells

In a traditional three-electrode cell, three different electrodes (working, counter, and reference) are placed in the same electrolyte solution. During three-electrode experiments, charge flow (current) primarily occurs between the working electrode and the counter electrode while the potential of the working electrode is measured with respect to the reference electrode. The WaveDriver 40 Cell Cable can be configured for three-electrode experiments by appropriate connection of the drive and sense lines.



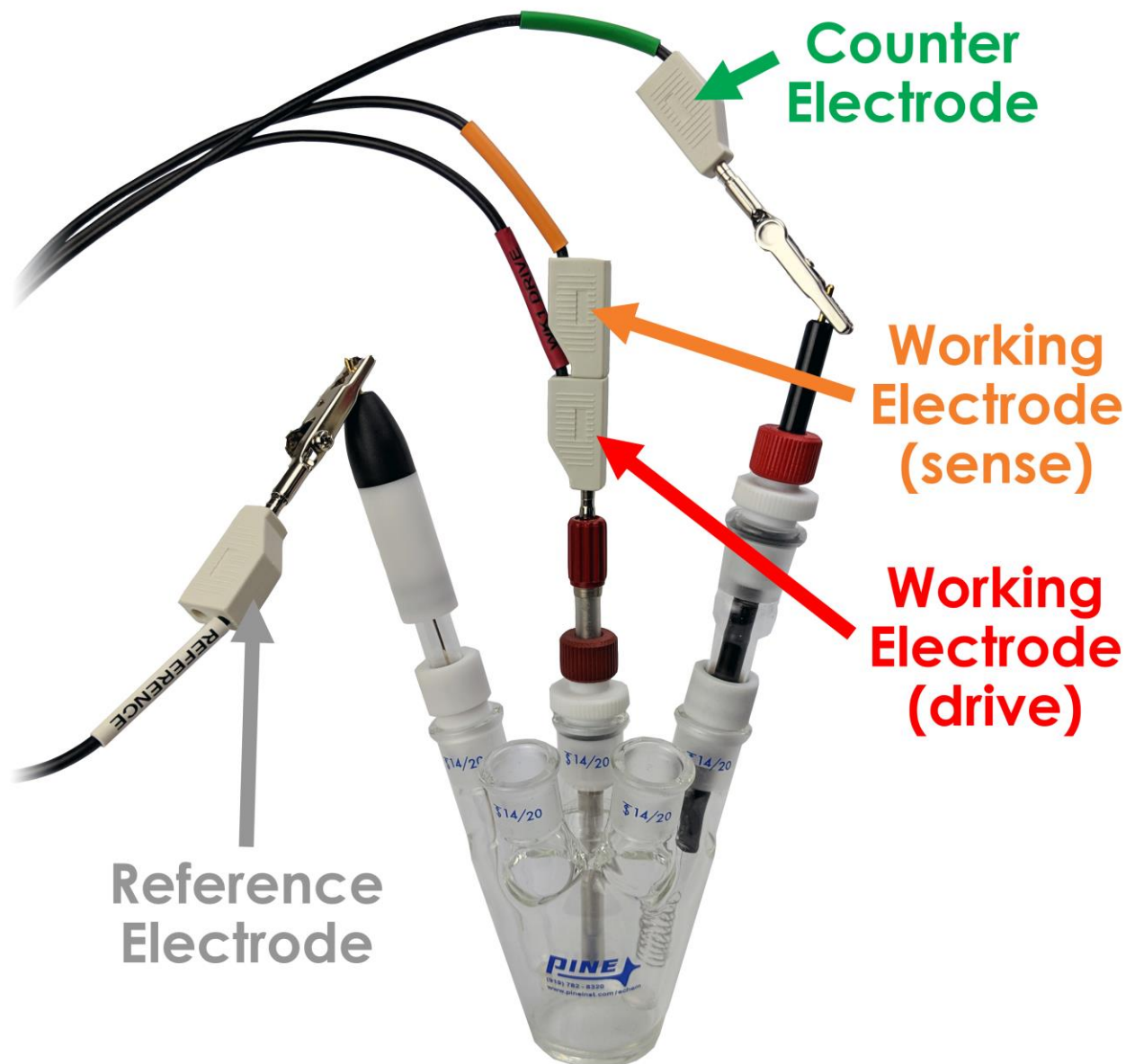

**Figure 5-5. Typical Three-Electrode Cell Configuration**

To drive current between the working and counter electrodes, the RED lead (K1 working electrode drive) is connected to the working electrode, and the GREEN lead (counter electrode drive) is connected to the counter electrode. To measure potential between the working and reference electrodes, the ORANGE lead (K1 working electrode sense) is also connected to the working electrode, and the WHITE lead (reference electrode sense) is connected to the reference electrode (see Figure 5-5).

Note that the three-electrode cell configuration requires both the RED and ORANGE leads (K1 working electrode drive and sense) to be connected at a point very near the working electrode. An easy way to make this connection is to stack the banana plugs for the RED and ORANGE leads together before connecting to the working electrode (see Figure 5-6). Both of these leads must be connected to the working electrode for the potentiostat to properly control the electrochemical cell.

When working with a traditional three-electrode cell, the second working electrode (K2) drive and sense lines (BLUE and VIOLET lines) are not used. These leads should be shorted together and set aside (see Figure 5-3). These lines are meant for use only with dual working electrode experiments such as those involving a rotating ring-disk electrode (see Section 5.2.4).



**Figure 5-6. Working Electrode Sense and Drive Leads (K1) Shorted Together near the Electrode**

### 5.2.3 Rotating Disk and Rotating Cylinder Electrodes (RDE and RCE)

The WaveDriver 40 may be used in conjunction with an electrode rotator to perform Rotating Disk Electrode (RDE) or Rotating Cylinder Electrode (RCE) experiments. These experiments are hydrodynamic variations of traditional three-electrode voltammetry. Rotating the working electrode (which may have a disk or cylinder geometry) at a controlled rate establishes convective mass transfer of electrolyte solution (and dissolved electroactive species) towards the electrode surface. Connecting the potentiostat to a hydrodynamic experiment involves not only making connections to the electrodes (working, counter, and reference) but also providing a rotation rate control signal to the electrode rotator.

The WaveDriver 40 Cell Cable can be used for these hydrodynamic experiments by making similar connections as those used in typical three-electrode cells (see Section 5.2.2). The GREEN lead (counter electrode drive) is connected to the counter electrode, and the WHITE lead (reference electrode sense) is connected to the reference electrode. Connections of the RED and ORANGE leads (K1 working electrode drive and sense) to the rotating working electrode are typically made via spring-loaded brush contacts that push against the shaft of the rotating electrode.





**Figure 5-7. Working Electrode Connection for a Rotating Disk or Rotating Cylinder Electrode**

As an example of how connections are made to a rotating working electrode, consider the brush contacts on the popular Pine Research MSR Rotator system (see Figure 5-7). This rotator system features two pairs of opposing brushes on either side of the rotating shaft. The upper pair of brush contacts (RED) is used to make electrical contact with a rotating disk or cylinder electrode mounted in the rotator. The RED and ORANGE cell cable leads (K1 working electrode drive and sense) should be stacked together and connected to the upper pair of brush contacts. Note that for the Pine Research MSR Rotator, it is also common practice to use a short banana cable to connect opposing brushes (see Figure 5-7, right).

#### 5.2.4 Rotating Ring-Disk Electrodes (RRDE)

A rotating ring-disk electrode (RRDE) cell contains a total of four electrodes – two working electrodes (disk and ring), one counter electrode, and one reference electrode. During an RRDE experiment, the WaveDriver 40 operates as a bipotentiostat, measuring the currents at the disk and ring electrodes (charge flows between the ring, the disk, and the counter electrode) while simultaneously measuring the potentials of the disk and ring electrodes with respect to the single reference electrode.

In an RRDE experiment, the counter and reference electrode connections are made in the same manner as for three-electrode cells (see Section 5.2.2). The GREEN lead (counter electrode drive) is connected to the counter electrode, and the WHITE lead (reference electrode sense) is connected to the reference electrode.

The exact details for connecting the K1 and K2 signal lines to the disk and ring depend upon the particular electrode rotator being used. There are typically one or more brushes that contact the disk electrode and also one or more additional brushes that separately contact the ring electrode.

As an example of how to connect to an RRDE, consider the brush contacts on the Pine Research WaveVortex 10 Rotator system (see Figure 5-8). This rotator system features two brushes (one for each electrode) that are connected to banana jacks on the motor unit. The RED and ORANGE cell cable leads (K1 working electrode drive and sense) should be stacked together and connected to the disk electrode using the RED banana jack on the motor unit. The BLUE and VIOLET cell cable leads (K2 working electrode drive and sense) should be stacked together and connected to the ring electrode using the BLUE banana jack on the motor unit.

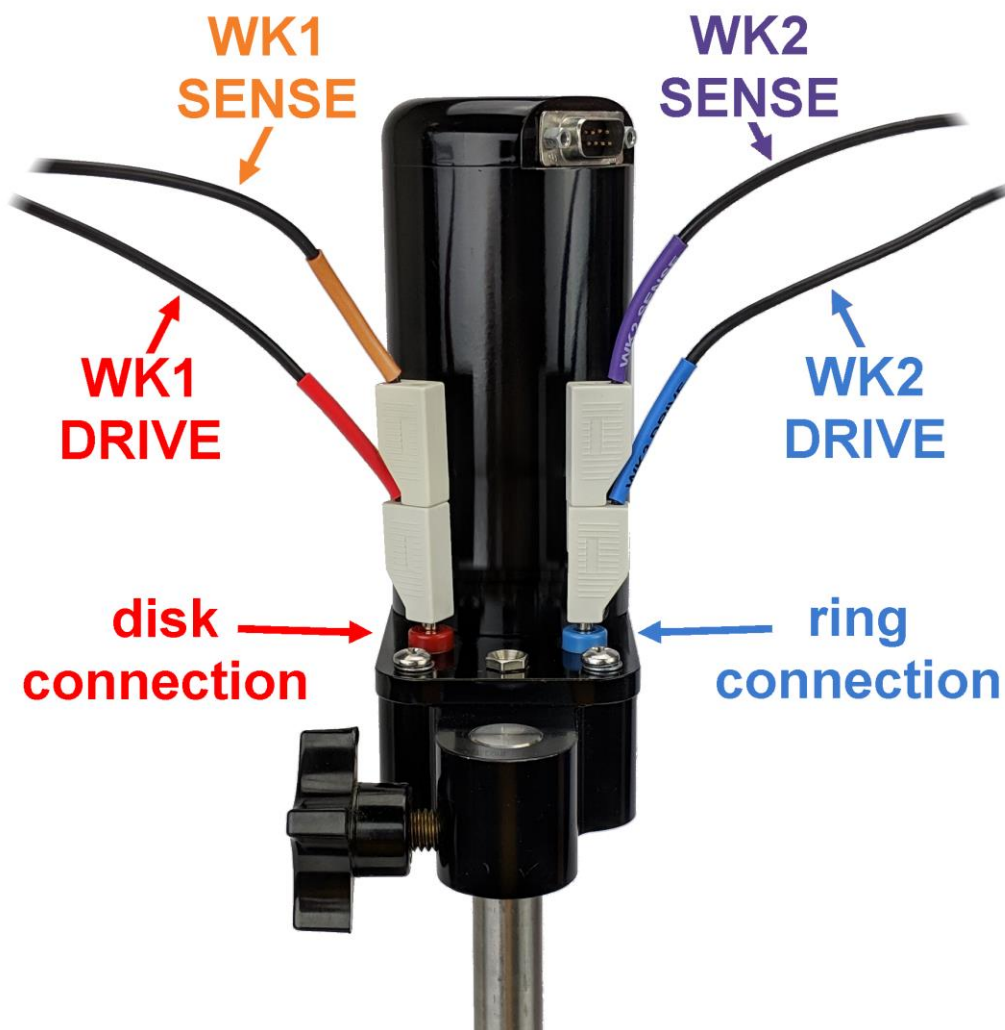

Figure 5-8. Electrode Connections for a Rotating Ring-Disk Electrode

### 5.2.5 Rotation Rate Control

Many electrode rotators can accept rotation rate control signals from a potentiostat. The WaveDriver 40 instrument provides both a digital "on/off" signal and an analog rotation rate signal that can be used to control the motor on an electrode rotator. These signals output from a connector on the back panel of the WaveDriver 40 (see Table 2-5). Special cables are available from Pine Research that may be used to connect these signals to various electrode rotator models.

**CAUTION:**

When connecting a WaveDriver 40 system to an electrode rotator other than the Pine Research MSR or WaveVortex 10 Rotator, carefully consider the magnitude of the WaveDriver 40 rate control signal ratio (1 RPM/mV) and take steps to assure that the rotator is configured to use the same ratio.

**ATTENTION:**

Lorsque vous connectez un appareil WaveDriver 40 à un rotateur à électrodes autre que le rotateur Pine Research MSR ou WaveVortex 10, faites très attention à la valeur du rapport du signal de contrôle de vitesse de l'appareil WaveDriver 40 (1 tr/min/mV) et assurez-vous que le rotateur soit configuré avec le même rapport.

Connecting a Pine Research WaveDriver 40 to a Pine Research MSR rotator requires a special cable (part number AKCABLE4). One end of this cable has a small green connector that fits into Control Port "B" on the back panel of the WaveDriver 40. The other end of the cable connects to the MSR control unit at two locations (see Figure 5-9). The coaxial portion of the cable connects to the pair of INPUT jacks on the front panel of the control unit. The other part of the cable terminates at a banana plug that is connected to the MOTOR STOP jack on the back panel of the control unit.



Figure 5-9. Rotation Rate Control Connections for a Pine Research MSR Rotator



**Figure 5-10. Rotation Rate Control Connections for a Pine Research WaveVortex 10 Rotator**

Connecting a Pine Research WaveDriver 40 to a Pine Research WaveVortex 10 rotator requires a special cable (part number AKCABLE7-03). One end of this cable has a small green connector that fits into Control Port “B” on the back panel of the WaveDriver 40. The other end of the cable terminates at a large green connector that fits into the control port on the side of the WaveVortex 10 control unit (see Figure 5-10).

### 5.2.6 Compact Voltammetry Cell Cable Connections

The following information details how to connect the WaveDriver 40 Cell Cable to the Pine Research Compact Voltammetry Cell Kit (available separately). This configuration involves the use of a second generic cell cable (part number RRPECBL2, available separately) that terminates with a mini-USB style plug. The other end of this cable contains four signal lines terminating in banana plugs: RED working drive electrode, ORANGE working sense electrode, GREEN counter electrode, and WHITE reference electrode.



The Compact Voltammetry Cell Kit consists of a grip mount, cell cap, glass vial, and various screen-printed electrodes. Built into the grip mount is a mini-USB port that may be connected to the mini-USB end of the second generic cell cable. Circuitry within the grip mount makes electrical connection to the screen-printed electrode mounted in the bottom of the device (see Figure 5-11). The four banana plugs on the other end of the generic cell cable can then be connected to the corresponding colored leads on the WaveDriver 40 Cell Cable using alligator clips or by stacking them into the banana jacks on the back of each lead. This simple cable configuration makes the Compact Voltammetry Cell Kit ideal for use in educational settings and confined spaces such as gloveboxes.

It should be noted that the connection between the WaveDriver 40 Cell Cable and the generic cell cable causes a break in the shielding, meaning the driven shield from the potentiostat does not extend all the way to the mini-USB style plug. This extra connection and lack of complete shielding may result in a decrease in the signal-to-noise ratio.



Figure 5-11. Cable Connections for the Compact Voltammetry Cell Kit

## 6. Grounding Information

The general goal of an experiment grounding strategy is to reduce the level of signal noise in the electrochemical measurement caused by noise sources in the laboratory environment. To avoid issues with laboratory noise sources, it is important to properly ground all metal objects near an electrochemical setup and to make appropriate grounding connections between the potentiostat and any other electronic equipment used as part of the experiment.

### 6.1 Common Noise Sources

A modern laboratory is often full of noise sources that can interfere with the measurement of small amplitude electrochemical signals. Computers, LCD displays, video cables, network routers, network cables, ovens, hotplates, stirrers, and fluorescent lighting are all examples of common laboratory items that may electromagnetically interfere with a delicate electrochemical measurement.

The electrochemical setup, potentiostat, cell cable, and any other experimental equipment (e.g., electrode rotator) should be located as far away from noise sources as possible. It is especially important that the cell cable is located well away from any digital noise sources such as mouse or keyboard cables, network cables, video cables, USB cables, cell phones, etc. The reference electrode cable is particularly sensitive to picking up noise from the environment. Also, any piece of laboratory equipment that intermittently draws a lot of current, such as an oven or hotplate under thermostatic control, should not be powered using the same branch circuit as the potentiostat. When such a piece of equipment goes through a power cycle, it may induce noise or a glitch in the electrochemical measurement.

### 6.2 Grounding Terminology

A potentiostat or other piece of electronic equipment generally has three types of grounding connections that are often confused with one another: the **earth ground**, the **chassis terminal**, and the **DC Common**. These are discussed in more detail below.

#### 6.2.1 Earth Ground



#### **EARTH GROUND:**

**An earth ground connection is a direct physical and electrical connection to the Earth.**

An earth ground connection is available in most modern laboratories via the third prong on the power receptacle for the local power system (see Figure 6-1). The power system infrastructure for a laboratory building usually has a long metal probe buried in the earth, and the third prong of the electrical outlets in the building wiring is connected to this earth connection. Many scientific instruments have a three-prong power cord that brings the earth ground connection to the instrument's power supply. Depending on the design of the instrument, the earth ground connection may or may not pass through the power supply to the circuitry inside the instrument.

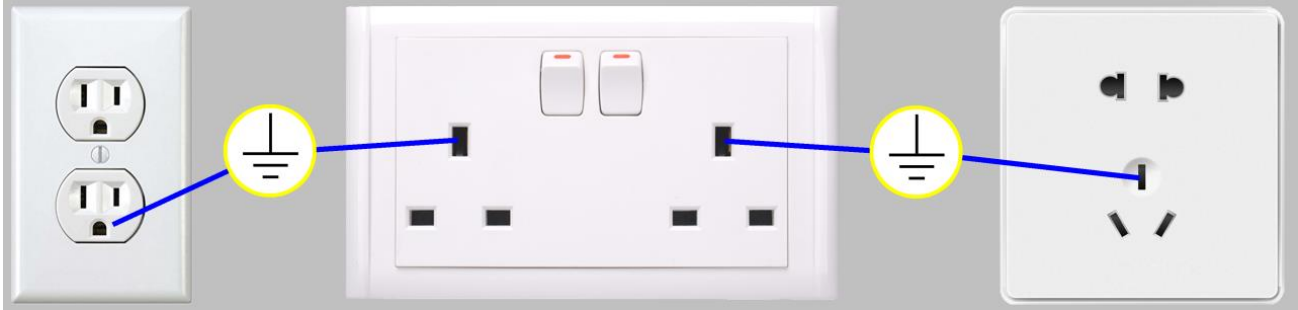

**Figure 6-1. Location of Earth Ground on Common Electrical Receptacles**

The power supply for the WaveDriver 40 does not allow the earth ground connection to pass through to the instrument circuitry. As a result, there is no permanent, direct connection to the earth ground when the instrument is connected to the AC Mains (there is no connection to earth ground via the power cable plugged into a receptacle).

If necessary for a given experimental arrangement, a separate and deliberate connection to earth ground can be employed. Third-party grounding kits are available that provide a convenient connection to the earth ground found on most electrical receptacles (see Figure 6-2).



**Figure 6-2. A Typical Earth Ground Connection Adapter with Banana Cable**

In general, a connection to earth ground need only be made if it helps to reduce (or, at least, has no effect on) the amount of noise in the electrochemical signals being measured. In some laboratory environments and for certain types of experiments (e.g., AC methods), making a connection to earth ground may actually increase the amount of signal noise. Some trial-and-error experimentation may be necessary to decide whether or not to make a connection to earth ground.



## 6.2.2 Chassis Terminal



### CHASSIS TERMINAL:

**A metal case that surrounds and protects the electronic circuitry is called a chassis. A convenient connection point to this chassis is called a chassis terminal.**

The metal case that contains the WaveDriver 40 circuitry is the instrument chassis. The chassis helps to protect the circuitry from environmental noise sources and ESD events. There are two convenient access points to the instrument chassis: the GRAY banana plug on the cell cable (see Table 5-1) and the metal banana jack on the back panel (see Table 2-5).

The WaveDriver 40 cell cable has a mesh shield that is directly connected to the instrument chassis (see Table 2-3 and Section 5.1). This mesh shield effectively extends the instrument chassis along the length of the cell cable until the point where the mesh terminates and the individual cable lines emerge (see Figure 5-2).

Some experiments require that the cell cable be extended beyond its usual length. Examples include routing a long cell cable through the side of a glovebox or using the additional cable associated with the Compact Voltammetry Cell Kit (see Section 5.2.6). When the cell cable is extended beyond its normal length, the protection afforded by the mesh should also be extended whenever possible. One way to do this is to wrap the additional lengths of cable in aluminum foil and then make a deliberate connection between the foil and the instrument chassis.

When multiple measurement devices are used together in an experiment, it is common practice to connect the instrument chassis terminals for all of the instruments together. It is also common practice to place the electrochemical cell in a Faraday cage and connect the Faraday cage to the instrument chassis. These connections assure that the sensitive measurement circuitry in the various instruments and the electrochemical cell are all effectively sharing the same outer shield against environmental noise.

## 6.2.3 DC Common



### DC COMMON:

**In an analog circuit, the DC Common is the zero reference point against which signal voltages are measured. This point is also known as the analog ground, signal ground, or signal common.**

The DC Common for the WaveDriver 40 is the zero volt (0.0 V) reference point used by the waveform generation and signal measurement circuits. There are two convenient access points to the DC Common: the BLACK banana jack on the back panel of the instrument and the center pin of Rotator Control Port B also located on the back panel (see Table 2-5).

The WaveDriver 40 may send or receive analog signals to and from other electronic instruments, such as a waveform generator, an x-y recorder, a digital oscilloscope, an electrode rotator, a spectrometer, or a quartz crystal microbalance. These other instruments also have a DC Common line that represents

the common “zero volt” analog signal level. In general, the act of connecting a signal cable from the WaveDriver 40 to another instrument connects the DC Common lines for both instruments.

The WaveDriver 40 offers separate connection points for DC Common and chassis terminal on the back panel (see Figure 2-1 and Table 2-5). By default, the instrument is shipped from the factory with a white shorting bar that connects the DC Common to the chassis terminal (see Figure 6-5 and Section 6.6 for further discussion). If desired, this shorting bar can be removed to allow the DC Common line to “float” with respect to the chassis.

The act of deliberately floating the DC Common signal with respect to the instrument chassis may or may not reduce the amount of environmental noise picked up by the potentiostat. For any given experimental configuration, some trial-and-error experimentation may be required to determine the optimal configuration.

There are situations in which a floating DC Common is required. The most common cases are those in which one of the electrodes (usually the working or counter electrode) is part of a third-party apparatus (such as a quartz crystal microbalance or an electroplating system), and the third-party apparatus is known to make a direct connection between the electrode and the instrument chassis or earth ground. When an electrode is known to be grounded by a third-party apparatus, it is critical that all of the analog measurement signals in the WaveDriver 40 (including the DC Common) are floating with respect to the chassis and/or earth ground. Otherwise, an undesirable short circuit pathway between the electrode and DC Common is likely to occur via the third-party apparatus.

Finally, it is important to be aware of cases where a hidden connection indirectly compromises the floating DC Common. These cases can occur when multiple instruments and/or computers are interconnected with the WaveDriver 40 as part of a larger experimental configuration. One of the other instruments may make an internal connection between DC Common and the chassis or earth ground. Finding and eliminating such hidden connections often requires some detective work using an ohmmeter.

### 6.3 Faraday Cages

When making sensitive electrochemical measurements (e.g., electroanalytical methods employing DC currents less than one microampere ( $< 1 \mu\text{A}$ )), it is very important to place the entire electrochemical cell inside a metal Faraday cage to shield the experiment from environmental noise. In addition, the portion of the cell cable (near the electrochemical cell) where the individual signal lines emerge from the protective mesh should also be placed inside the Faraday cage.

After placing the ends of the cell cable and the electrochemical cell inside of the Faraday cage, a secure electrical connection should be made between the metal Faraday cage and the WaveDriver 40 chassis terminal. This combination of the instrument chassis, the mesh around the cell cable, and the Faraday cage essentially puts the entire system (circuitry and cell) inside of an overall outer protective shield (i.e., the cell cable mesh and the Faraday cage act as an extension of the instrument chassis).

A Faraday cage can either be purchased directly from a supplier or fabricated using inexpensive and commonly-found materials. Anything from a commercial electrical enclosure to a cardboard box lined with aluminum foil can serve as a functional Faraday cage (see Figure 6-3). A Faraday cage requires an internal volume large enough to contain the entire electrochemical cell and all of the banana plugs at the end of the cell cable that connect to the various electrodes. Care should be taken to ensure that the electrode connections do not accidentally come into contact with the conductive walls of the Faraday cage.



Figure 6-3. Common Examples of Faraday Cages

## 6.4 Metal Apparatus

Electrochemical cells are often mounted using various metal apparatus (such as ring stands or laboratory clamps). These mounts, along with any other metal objects located near the electrochemical setup, can interfere with sensitive electrochemical measurements, especially if they are simply allowed to “float” rather than being electrically connected to a known point in the system. Some trial-and-error may be required to determine the best way to ground such metal objects, but in many cases, an alligator clip and a banana cable (see Figure 6-4) can be used to connect the metal object to the instrument chassis or to the earth ground or to both.



Figure 6-4. Metal Objects Near the Electrochemical Cell Should Be Grounded

## 6.5 USB Isolation

It is important to note that the WaveDriver 40 is designed to be connected to a personal computer (tower, desktop, or laptop) via a USB cable. It is generally undesirable for the chassis of the instrument to be connected to the chassis of the computer. To help isolate the WaveDriver 40 from the computer,

the USB port (on the back panel) is mounted in a manner that helps prevent direct shorting between the instrument chassis and the computer chassis via the USB cable. Note that the USB shield line is capacitively coupled to the chassis of the WaveDriver 40.

The communications lines within a USB cable carry digital signals and at least one line that is connected to the DC Common of the computer. To prevent interaction between the circuitry inside the computer and the sensitive measurement circuitry inside the instrument, the WaveDriver 40 has special circuitry that isolates the USB lines from the rest of the system. This prevents the DC Common of the computer from being connected to the DC Common of the instrument.

## 6.6 Grounding Strategies

The first step in determining the optimal grounding configuration for any electrochemical experiment is to understand the grounding configuration of the potentiostat itself. There are several possible ways in which the instrument chassis, the DC Common, and the earth ground might be connected. A summary of the most common configurations is provided (see Figure 6-5).

When the WaveDriver 40 is shipped from the factory, a white shorting bar is pre-installed on the back panel that bridges the DC Common and instrument chassis banana binding posts (see Figure 6-5A). This "DC Common-to-chassis" configuration may be suitable for some electrochemical experiments; however, in other situations it may be better to disconnect this metal shorting bar to obtain a "fully floating" condition.

In situations where it is desirable to have a "fully floating" arrangement where the DC Common floats with respect to the instrument chassis, the shorting bar may be disconnected from the DC Common and instrument chassis jacks (see Figure 6-5B). This arrangement is often required when one of the electrodes is actually part of a third-party apparatus (such as a quartz crystal microbalance or an electroplating system), and the third-party apparatus requires that the electrode be connected to the chassis or to the earth ground or to both. In these cases, the DC Common should be allowed to float with respect to the chassis to prevent an inadvertent short-circuit between the electrode and DC Common (via the third-party apparatus).

The WaveDriver 40 is designed so that no part of the instrument circuit is connected to earth ground by default. While the external power supply does have an earth ground connection, the earth ground is not passed through the power supply to the instrument. If desired, a deliberate connection between earth ground and the instrument chassis may be made. Various cables and connectors (not included) can be used to make a connection from the chassis terminal on the back panel of the instrument to the third-prong on a nearby electrical receptacle (see Figure 6-2 and Figure 6-5C).

In certain situations, it may be desired to use a "fully earth grounded" configuration (see Figure 6-5D). Similarly to the previously-described "chassis-to-earth ground" configuration, this can require various additional cables and connectors (not included). However, in many cases, connections to earth ground can introduce unknown or unwanted sources of noise in the experimental results. If the experimental setup requires that the instrument be earth grounded, then some trial-and-error may be required to determine whether or not to also connect the DC Common to earth ground.

## 6.7 Grounding Third-Party Instrumentation

When using one or more third-party electronic instruments together with the WaveDriver 40, a common grounding strategy is to connect the chassis of the WaveDriver 40 to the chassis of the other instrument(s). All such connections should be brought together to a single point. Any other metal

objects located near the electrochemical cell (e.g., ring stands, Faraday cage, clamps, etc.) should be connected to the same single point to avoid creating a possible grounding loop (see Figure 6-6).

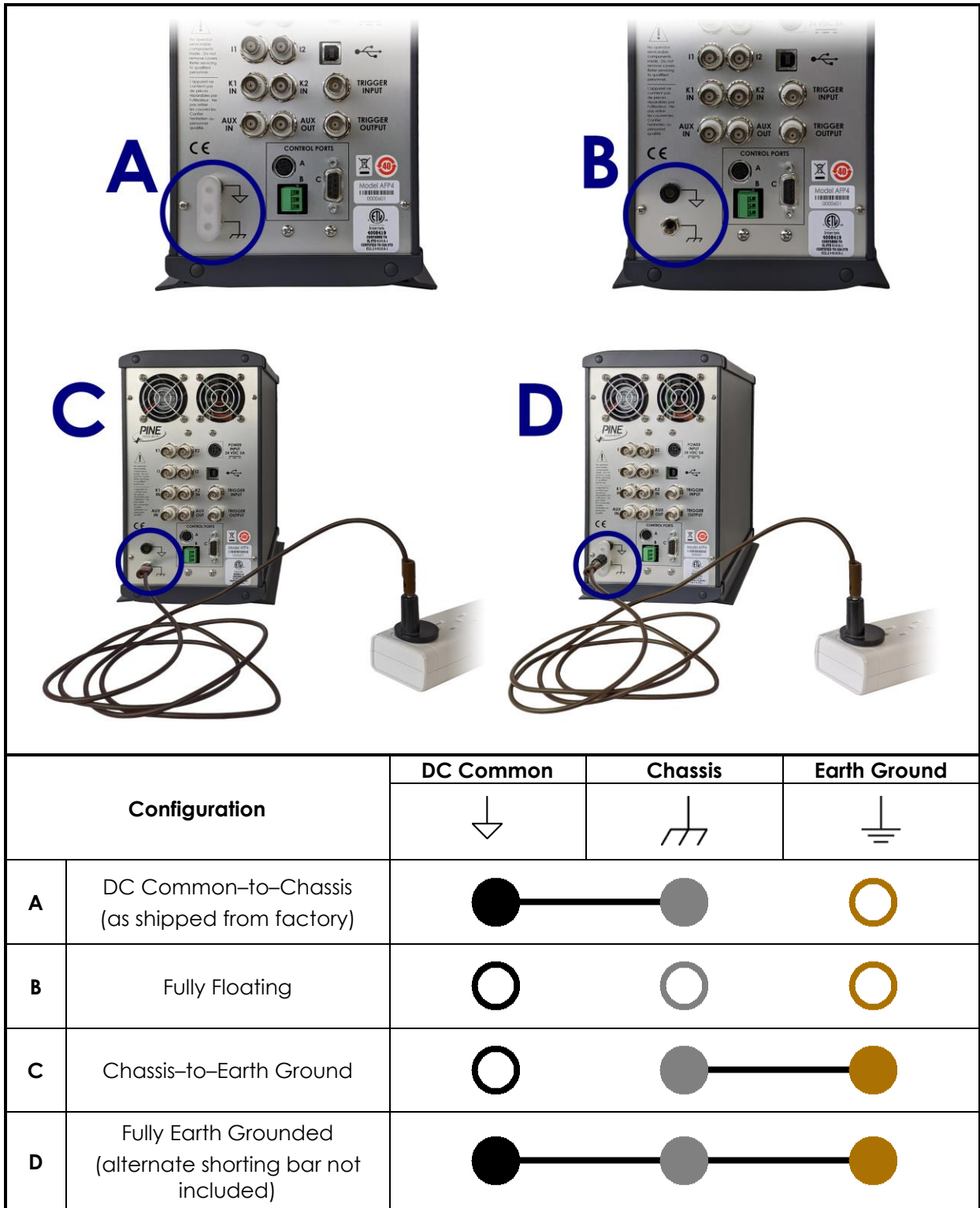

Figure 6-5. Four Common Instrument Grounding Configurations



**NOTE:**

If the WaveDriver 40 was purchased before April 2021, its back panel may be slightly different. For corresponding information on common grounding configurations, see Section 10.

When using third-party instrumentation, a decision must be made regarding whether or not to connect the chassis terminal to the earth ground. Some third-party equipment may actually force such a connection to earth ground, and sometimes this connection is hidden from view inside the third-party instrument. Trial-and-error, as well as the use of an ohmmeter, may be required to analyze and fully understand the grounding configuration when multiple instruments are used together.

Just like the WaveDriver 40, third-party instruments also have their own DC Common line that represents the common “zero volt” analog signal level within the third-party instrument’s circuit. When the WaveDriver 40 is connected to an electrode rotator control unit, a spectrometer, a quartz crystal microbalance, or other third-party instrument, a connection is almost always made between the DC Common lines of the various instruments. In these cases, it is important to be aware of whether or not the DC Common of a third-party instrument happens to also be connected to earth ground or to the instrument chassis. Such connections are sometimes hidden within the third-party instrument. Again, some trial-and-error, as well as the use of an ohmmeter, may be required to confirm whether or not the DC Common is floating with respect to the chassis (or with respect to earth ground).



**Figure 6-6. Connect All Instrument Chassis Terminals to a Common Point**

**NOTE:**





A grounding loop is often accidentally created when ground connections are made in series from one instrument to the next. The resulting loop can act as a large antenna that injects environmental noise into sensitive signal measurements.





To prevent accidental creation of a grounding loop, bring all grounding connections together to a common point.







## 7. Power Cords

The standard C14 connector on the WaveDriver 40 power supply is compatible with a wide range of power cords available from Pine Research. Each of the available power cords is rated at 10 A (minimum), and each cord is designed for use in a specific country or region of the world. Representative images and Pine Research part numbers are provided below (see Table 7-1).

Image	Description	Part Number	Notes
	Power Cord (USA)	EWM18B7	This cord is for use in the USA, Canada, Mexico, Brazil, Colombia, Saudi Arabia, and Taiwan
	Power Cord (Europe)	EWM18B8EU	This cord is for use in continental Europe, Korea, Russia, and Indonesia
	Power Cord (UK)	EWM18B8UK	This cord is for use in the United Kingdom, Ireland, Kuwait, Malaysia, Oman, Hong Kong, and Singapore
	Power Cord (China)	EWM18B8CN	This cord is for use exclusively in China

	<p>Power Cord (South Africa)</p>	<p>EWM18B8SA</p>	<p>This cord is for use in South Africa</p>
	<p>Power Cord (Israel)</p>	<p>EWM18B8IL</p>	<p>This cord is for use exclusively in Israel</p>
	<p>Power Cord (Japan)</p>	<p>EWM18B8JP</p>	<p>This cord is for use exclusively in Japan</p>
	<p>Power Cord (South Korea)</p>	<p>EWM18B8KR</p>	<p>This cord is for use exclusively in South Korea</p>
	<p>Power Cord (Argentina)</p>	<p>EWM18B8AR</p>	<p>This cord is for use exclusively in Argentina</p>

	Power Cord (Denmark)	EWM18B8DK	This cord is for use exclusively in Denmark
	Power Cord (Australia)	EWM18B8NZ	This cord is for use in Australia and New Zealand
	Power Cord (Switzerland)	EWM18B8CH	This cord is for use exclusively in Switzerland
	Power Cord (Italy)	EWM18B8IT	This cord is for use exclusively in Italy

**Table 7-1. Select Power Cords Available from Pine Research**

## 8. Glossary

<b>Anodic Current</b>	The flow of charge at an electrode as a result of an oxidation reaction occurring at the electrode surface. For a working electrode immersed in a test solution, an anodic current corresponds to flow of electrons out of the solution and into the electrode
<b>Auxiliary Electrode</b>	(see Counter Electrode)
<b>Banana Cable</b>	A banana cable is a single-wire (one conductor) signal cable often used to make connections between various electronic instruments. Each end of the cable has a banana plug. The plug consists of a cylindrical metal pin about 25 mm (1 in) long, with an outer diameter of about 4 mm (0.16 in), which can be inserted into a matching banana jack
<b>Banana Jack</b>	Female banana connector
<b>Banana Plug</b>	Male banana connector
<b>BNC Connector</b>	The BNC (Bayonet Neill-Concelman) connector is a very common type of RF connector used for terminating coaxial cables
<b>Cathodic Current</b>	The flow of charge at an electrode as a result of a reduction reaction occurring at the electrode surface. For a working electrode immersed in a test solution, a cathodic current corresponds to flow of electrons out of the electrode and into the solution
<b>Coaxial Cable</b>	Coaxial cable, or coax, is an electrical cable with an inner conductor surrounded by a flexible, tubular insulating layer, surrounded by a tubular conducting shield. The term coaxial comes from the inner conductor and the outer shield sharing the same geometric axis. A coaxial cable is often used to carry signals from one instrument to another in situations where it is important to shield the signal from environmental noise sources
<b>Counter Electrode</b>	The counter electrode, also called the auxiliary electrode, is one of three electrodes found in a typical three-electrode experiment. The purpose of the counter electrode is to carry the current across the solution by completing the circuit back to the potentiostat
<b>Cyclic Voltammetry (CV)</b>	A DC electroanalytical method where the working electrode potential is repeatedly swept back and forth between two extremes while the working electrode current is measured
<b>Direct Current (DC)</b>	A type of electrical flow where the current travels in only one direction
<b>Dummy Cell</b>	A dummy cell is a network of known resistors and capacitors that can be used to test a potentiostat to ensure that it is working properly. The dummy cell is used in place of an actual electrochemical cell when troubleshooting a potentiostat because the dummy cell provides a known response, whereas the response from an actual cell is complicated by chemical phenomena

<b>Electroactive</b>	An adjective used to describe a molecule or ion capable of being oxidized or reduced at an electrode surface
<b>Electrode</b>	An electrode is an electrical conductor used to make contact with a nonmetallic part of a circuit
<b>Electrostatic Discharge (ESD)</b>	The rapid discharge of static electricity between objects with different charges. Sensitive electronics in the path of an ESD event may suffer damage
<b>Faradaic Current</b>	The portion of the current observed in an electroanalytical experiment that can be attributed to one or more redox processes occurring at an electrode surface
<b>Half-Reaction</b>	A balanced chemical equation showing how various molecules or ions are reduced (or oxidized) at an electrode surface
<b>K1</b>	A symbol referring to the primary working electrode. Two connections (drive and sense) are required between the working electrode and the potentiostat
<b>K2</b>	A symbol referring to the secondary working electrode. Two connections (drive and sense) are required between the working electrode and the potentiostat
<b>Linear Sweep Voltammetry (LSV)</b>	A DC experiment in which the working electrode potential is swept from initial value to final value at a constant rate while the current is measured
<b>Non-Faradaic Current</b>	The portion of the current observed in an electroanalytical experiment that cannot be attributed to any redox processes occurring at an electrode surface
<b>Overpotential</b>	The overpotential is the difference between the formal potential of a half-reaction and the potential actually being applied to the working electrode
<b>Oxidation</b>	Removal of electrons from an ion or molecule
<b>Redox</b>	An adjective used to describe a molecule, ion, or process associated with an electrochemical (oxidation or reduction) reaction
<b>Reduction</b>	Addition of electrons to an ion or molecule
<b>Reference Electrode</b>	A reference electrode has a stable and well-known thermodynamic potential. The high stability of the electrode potential is usually achieved by employing a redox system with constant (buffered or saturated) concentrations of the ions or molecules involved in the redox half-reaction
<b>Standard Electrode Potential</b>	A thermodynamic quantity expressing the free energy of a redox half-reaction in terms of electric potential
<b>Sweep Rate</b>	Also called "scan rate", it is the rate at which the electrode potential is changed with time when performing a sweep voltammetry technique such as cyclic voltammetry or linear sweep voltammetry

---

<b>Three-Electrode Cell</b>	A common electrochemical cell arrangement consisting of a working electrode, a reference electrode, and a counter electrode
<b>Two-Electrode Cell</b>	A common electrochemical cell arrangement consisting of a working electrode and a counter electrode that also serves as the reference electrode
<b>Voltammogram</b>	A plot of current vs. potential from an electroanalytical experiment in which the potential is swept back and forth between two limits
<b>Working Electrode</b>	The electrode at which the redox process of interest occurs. While there may be many electrodes in an electrochemical cell, the focus of an experiment is typically only on a particular half-reaction occurring at the working electrode
<b>Working Electrode Drive</b>	The connection on a potentiostat or galvanostat through which charge flows to or from a working electrode. Drive lines have low impedance to allow significant charge flow (current) through the working electrode
<b>Working Electrode Sense</b>	The connection on a potentiostat or galvanostat that measures the potential of a working electrode. Sense lines have a high input impedance so that the potential can be measured without significant charge flow (current) through the sense line

## 9. Appendix I: Legacy Dummy Cell Information (before NOV 2020)

A WaveDriver 40 purchased before November 2020 was supplied with a different, legacy dummy cell. This section includes a description of that legacy dummy cell and also contains connection instructions corresponding to the potentiostat system testing in Section 4.

### 9.1 Legacy Dummy Cell Description

The dummy cell included with a WaveDriver 40 purchased prior to November 2020 was the Universal Dummy Cell (Pine Research part number AFDUM3). Below is an image of this dummy cell, along with schematics of its four separate circuit networks.

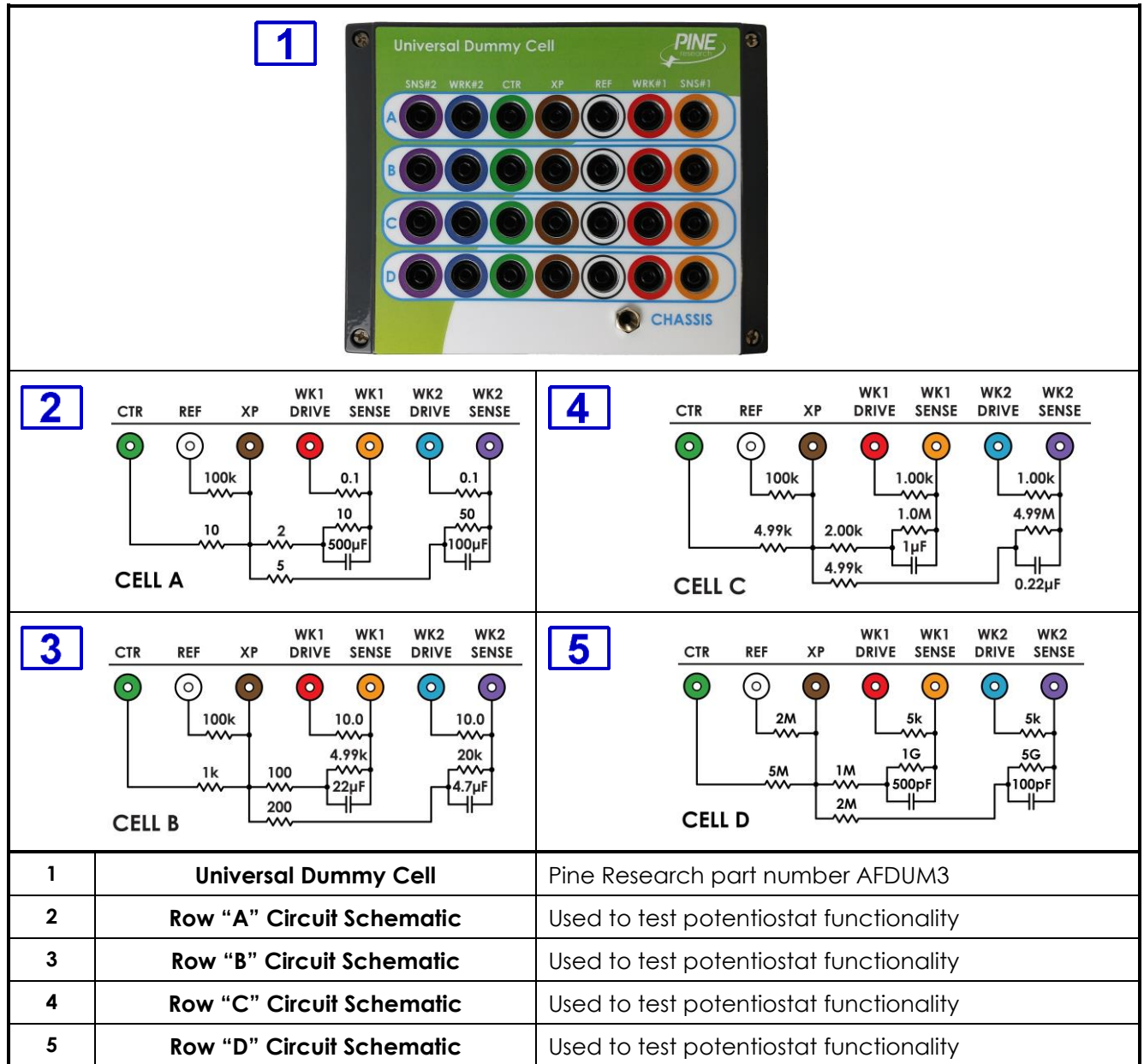

Figure 9-1. WaveDriver 40 Universal Dummy Cell (with Schematic Diagrams)



The circuit rows of the Universal Dummy Cell are used for testing the capabilities of the WaveDriver 40. All four rows have the same circuit topology; however, the values of the resistors and capacitors in each circuit row are different.

## 9.2 Connecting to Row “C” on the Universal Dummy Cell



**NOTE:**

**This section includes instructions for connecting to the dummy cell corresponding to system testing in Sections 4.2 and 4.3.**

Securely connect the cell cable to the front panel of the WaveDriver 40 (see Figure 9-2). Remove any alligator clips from the banana plugs and insert the plugs into the banana jacks with matching colors for each lead on Row “C” of the Universal Dummy Cell. Be sure to connect the GRAY banana plug (instrument chassis) to the chassis terminal located on the Universal Dummy Cell. Connecting the two chassis terminals together effectively shields the instrument circuitry and the components of the dummy cell within the same overall Faraday cage (see Section 6 to learn more about grounding).

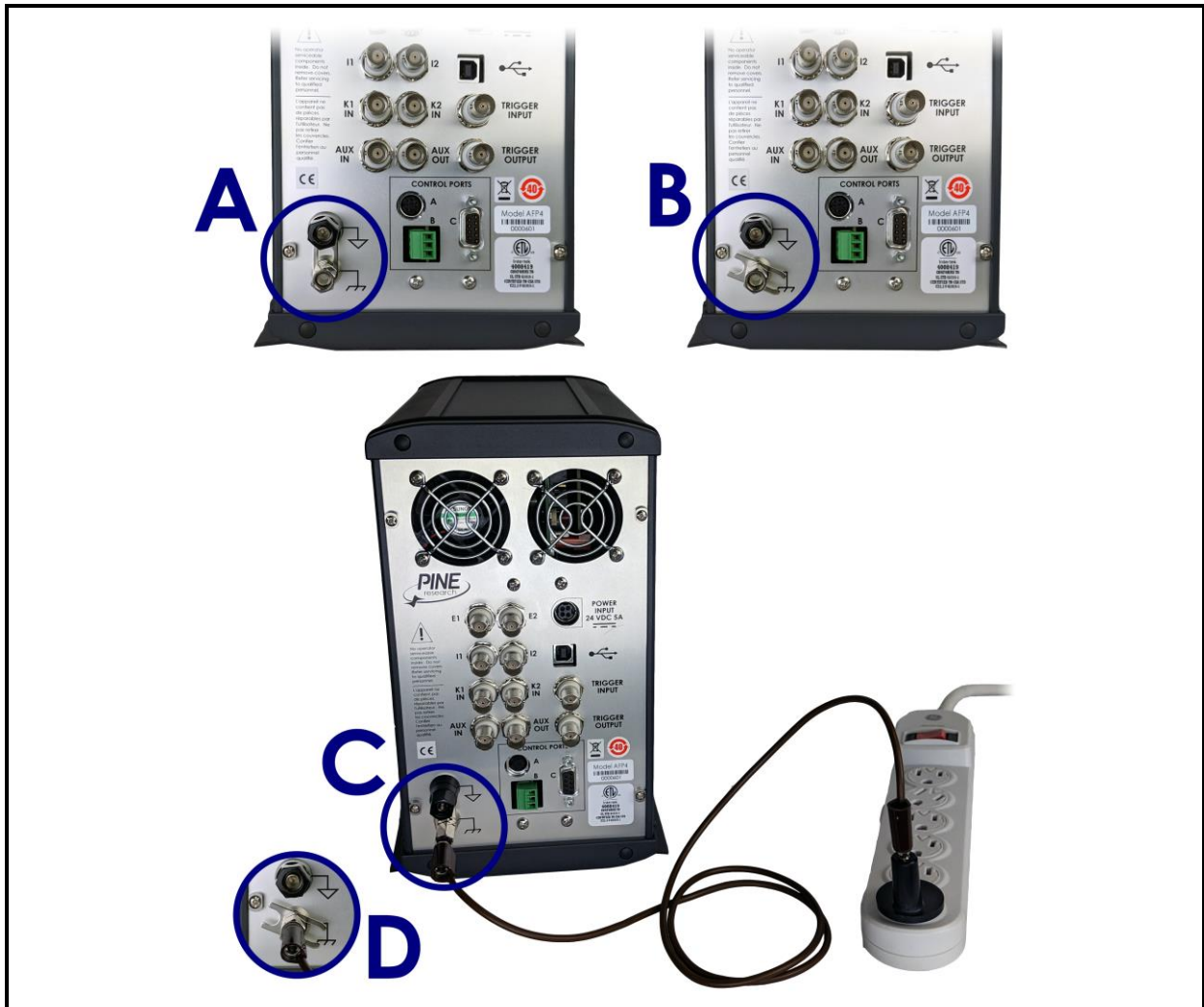

**Figure 9-2. WaveDriver 40 Cell Cable Connected to Universal Dummy Cell Row “C”**

## 10. Appendix II. Legacy Grounding Information (before APR 2021)

A WaveDriver 40 purchased before April 2021 had a slightly different back panel grounding configuration. The DC Common was a black binding post and the instrument chassis terminal was a metal binding post. A metal shorting bar was also pre-installed when shipped from the factory that shorted the DC Common and instrument chassis (see Figure 10-1).

A summary of the four different common grounding configurations on WaveDriver 40s purchased prior to April 2021 is shown below (see Figure 10-1). These images correspond to the grounding strategies discussion in Section 6.6.



Configuration		DC Common	Chassis	Earth Ground
		↓	⏏	⏏
A	DC Common-to-Chassis (as shipped from factory)	●	●	○
B	Fully Floating	○	○	○
C	Fully Earth Grounded	●	●	●
D	Chassis-to-Earth Ground	○	●	●

Figure 10-1. Four Common Instrument Grounding Configurations

## 11. Customer Support

After reviewing the content of this user guide, please contact Pine Research should you have any issues or questions with regard to the use of the instrument, accessories, or software.

Contact us anytime by the methods provided below:

### 11.1 Online

Our website has a contact form that allows users to submit technical support requests directly to Pine Research. Visit [www.pineresearch.com/contact](http://www.pineresearch.com/contact).

### 11.2 By E-mail

Send an email to [pinewire@pineresearch.com](mailto:pinewire@pineresearch.com). This is the general sales email and our team will ensure your email is routed to the most appropriate technical support staff available. Our goal is to respond to emails within 24 hours of receipt.

### 11.3 By Phone

Our offices are located in Durham, NC in the eastern US time zone. We are available by phone Monday through Friday from 9 AM EST to 5 PM EST. You can reach a live person by calling +1 (919) 782-8320.





## EU Declaration of Conformity

In accordance with EN ISO 17050-1:2010

**Object of the Declaration:**

Products: WaveDriver 40 Bipotentiostat/Galvanostat  
WaveDriver 100 Potentiostat/Galvanostat  
WaveDriver 200 Bipotentiostat/Galvanostat

Models: AFP3, AFP4, AFP5

Serial numbers: 4318nnn and later (wwyynn: where ww is the week of manufacture; yy is the year of manufacture; nnn is a number indicating model and sequence of build)

Manufacturer: Pine Electronics, Inc.  
Address: 101 Industrial Drive, Grove City, PA, 16127, USA

This declaration is issued under the sole responsibility of the manufacturer.

**The object of the declaration described above is in conformity with the relevant Union harmonization legislation:**

Directive	Title
2014/35/EU	The Low Voltage Directive
2014/30/EU	The Electromagnetic Compatibility Directive
2011/65/EU	The Restriction of Hazardous Substances Directive

**Conformity is shown by compliance with the applicable requirements of the following documents:**

Reference and Date	Title
EN 61326-1:2013	EMC Requirements for electrical equipment for measurement, control and laboratory use
IEC 61010-1:2010, AMD1:2016	Safety Requirements for electrical equipment for measurement, control and laboratory use

---

Signed for and on behalf of: Pine Electronics, Inc./Pine Research Instrumentation, Inc.  
Place of Issue: Grove City, PA, USA  
Date of Issue: 03/04/2019  
Name: Edward T. Berti  
Position: Principal Engineer  
Signature: 

---

The technical documentation for the machinery is available from the above address.

The CE Mark was applied per the following reports:

Keystone Compliance: 1807-092EB

Intertek: 103640745COL-001 and 103640745COL-002